



ONE  
CATALOGUE  
2026-27



Trusted by surfers for a lifetime.  
Born in Australia.





T R U S T E D



**" I won a leggie in a surf comp and it broke,  
I thought I could easily make something  
better and that's where it all began."**

*Brian Cregan*

BRIAN CREGAN  
FOUNDER/OWNER/MANAGING DIRECTOR



## CONTENTS

### SURF HARDWARE

LEASHES	6
BOARDCOVERS	26
BOARDCOVER ACC	58
TAIL PADS	60
TRAVEL RAX / TIE DOWNS	74
BOARD STORAGE	78
KEY VAULTS	86
RESIN & REPAIR KITS	88
SURFBOARD FINS	90
BODYBOARD ACCESSORIES	92
WAX / ACCESSORIES	96
TOW SERIES	98

### SOFTBOARDS

THE SLUG	102
RAZOR	104
THE BUG	106
EZI-RIDER 2.0	108
GENERAL EPOXY SOFT	110
KK EPOXY SOFT	112
SAR BEAR EPOXY SOFT	114
HAPPY HOUR EPOXY SOFT	116
HAPPY HOUR PU	118
SURF SCHOOL BOARDS	120
SOFTBOARD COMPONENTS	126

### WETSUIT/LYCRA & ACC

MENS WETSUITS	128
YOUTH WETSUITS	138
VESTS	140
FLAME THERMO SKINS	142
RIB GUARD VESTS	143
WOMEN'S WETSUITS	144
HOODS	146
GLOVES	147
BOOTIES	148
WETSUIT ACCESSORIES	152
MENS + BOYS LYCRA	154
LADIES + GIRLS LYCRA	158

### SURF ACCESSORIES

SURF HATS	162
FORCES OF NATURE	172
PONCHOS	174
TOWELS	185
WATERPROOF WETSUIT BAGS	186
WATERSPORT PRODUCTS	188

### SUMMER ACC

GLOBAL TRAVEL SERIES	190
INSULATED HYDRATION	192
INSULATED WATER BOTTLES	194
CANE HATS	196
CAPS	198
HATS	200
WALLETS	201

### CONTACT

O+E CONTACT DETAILS	202
---------------------	-----

**APEX**

POWERED BY EXPERIENCE & INNOVATION.  
REDEFINING WHAT THE FUTURE FEELS LIKE.



L E A S H

COMING  
2027



DAKODA WALTERS

## LEASHES

The range seamlessly blends time-tested design and trusted craftsmanship with cutting-edge materials to offer surfers a leash series that not only delivers unmatched strength, but also carries the weight of a storied legacy, making it the number 1 choice for those who demand uncompromising reliability and performance in their surfing experience.



PATENTED

WORLD'S STRONGEST LEASH

The One Piece leash technology's extruded cord design eliminates the moulded end join which is the weakest point in traditional leashes. Constructed using a new production technique, 8mm swivels and a unique new formula in the urethane cord, this leash has superior strength, stretch and memory retention.

## DIAMOND FLEX

ADVANCED MOULDED DESIGN

Advanced mould design with flex diamonds provides controlled flex. Designed to stretch with the urethane cord.

## SUNSET (DIAMOND FLEX)

MOULDED DESIGN

Diamond-Flex moulds, stainless steel swivel and premium grade urethane.



## WORLD'S STRONGEST LEASH

NO JOINS , NO WEAK POINTS | 40% STRONGER

### ONE XT PREMIUM

The One Piece Leash's extruded cord design eliminates the moulded end join which is the weakest point in traditional leashes. Constructed using a new production technique, 8mm swivels and a unique new formula in the urethane cord, this leash has superior strength, stretch and memory retention.



#### ONE PIECE CORD

No Joins.  
No Weak Points.  
40% Stronger

#### TRADITIONAL MOULDED CORD

Weakest point where cord meets moulded end.



**ONE PIECE EXTRUDED CORD**

From swivel to swivel - just one cord... one component. Eliminates the need for end joins, which are the weakest points in conventional leashes, meaning no weak points.

**CONTROLLED-STRETCH URETHANE**

The larger the wave, the more stretch which keeps your board at a safe distance away. Premium grade quality urethane developed by the world's leading manufacturer.

**ORIGINAL DETACHABLE RAILS AVER**

The original railsaver system designed by O&E, with sewn in anchor cord. Protects rails and is easily detached.

**LEASH SIZE LABEL**

Easily identify your leash sizes

**PLUG BUDDY**

Another O&E first. Ensures leash string can be easily slipped through surfboard plug.

**8MM DUAL ANCHOR STEEL SWIVELS**

Marine grade, stainless anti-corrosive free-spin swivels for tangle-free surfing.

**SAFETY RELEASE PULL TAB**

New PU 'Easy access' pull tab. Less resistance/drag. Essential when surfing big waves and reefs.  
\*Premium ONE-XT leashes only

**COMFORT STRAP\***

A slightly wider, contoured neoprene ankle strap. Prevents discomfort from leash strap pulling on your heel, ankle and achilles. It's all about comfort through design.  
\*Premium ONE-XT leashes only

WARRANTY  
**12**  
MONTHS

**WARRANTY**

Guaranteed against faulty workmanship or defective materials for 12 months from date of purchase.



**SAFETY RELEASE PULL TAB**

New PU 'Easy access' pull tab. Less resistance/drag. Essential when surfing big waves and reefs.  
\*Premium ONE-XT leashes only



**ANTI-SLIP STRAP**

Is an engineered raised non-slip silicone print, positioned on the inside of the neoprene ankle strap and minimises strap movement.



**WATER REPELLENT OUTER STRAP**

The strap's outer material is water repellent. Minimising the weight even when surfed.



**CURVED STRAP PLUG**

Designed for comfort which naturally curves around your ankle.

**ONE XT**  
**PREMIUM**



PREMIUM ONE - XT



**PREMIUM ALLROUND / COMP 6'0**

LC60XT

Light enough to surf a 2ft shorey, strong enough to charge a 5ft bombie. This 6mm cord has equal strength to competitor's 7mm moulded leashes.

Wave Size: 6ft (1.2m)  
Cord Ø: 6mm (1/4")  
Strap: 38mm



**PREMIUM 6'**

LP60XT

Your everyday leash. Ride up to 8ft waves. The premium 6 is so strong it will probably outlast your board.

Wave Size: 8ft (2.4m)  
Cord Ø: 7mm (9/32")  
Strap: 38mm



**PREMIUM 7'**

LP70XT

When the swell picks up so should the length in your leash. Waves up to 10ft.

Wave Size: 10ft (3.0m)  
Cord Ø: 7mm (9/32")  
Strap: 50mm



**PREMIUM 8'**

LP80XT

If you've got a step up board you need a step up leash. Charge waves up to 12ft.

Wave Size: 12ft (3.7m)  
Cord Ø: 7mm (9/32")  
Strap: 50mm



**ONE XT**  
**BIG WAVE**

Ocean & Earth is well known as the world's leading leash company for the past 40 years. This attribute comes from designing the best leashes for all waves breaking around our planet. We design the strongest leashes to withstand the biggest waves with surfer safety as priority. The Big Wave series has design features that make surfing these monster waves possible. "The belief to take it on. The product that makes it possible"

MATT BROMLEY



**QUICK RELEASE PIN**

A quick release, stainless steel pin that allows the leash to be separated from your board in dangerous hold downs. Large easy grab loop for easy release. A webbing anchor tape is attached to the pin and strap. You won't lose the pin when released.



**LONGER TRIPLE WRAP VELCRO ANKLE STRAP**

The power of monster waves can rip single velcro wrap leashes from your ankle. This specially designed triple wrap strap stays secure.



**EXTRA WIDE RAIL SAVER**

A wider, longer, stronger rail saver with extra triple wrap velcro adds to the strength and security. Also comes with two 4mm heavy duty leash plug cords for backup strength. Now with Leash Size identification label.

BIG WAVE ONE - XT



BLACK



**BIG WAVE 8'0**

LB80XT

Ride slabs up to 12ft with peace of mind knowing you have a quick release pin if you get caught on those sketchy ledges.

Wave Size: 12ft+ (3.7m+)  
Cord Ø: 9mm (3/8")  
Strap: 50mm



BLACK



**BIG WAVE 10'0**

LP10XT

Designed for 15ft+ waves. Man up and get out there!

Wave Size: 15ft+ (4.6m+)  
Cord Ø: 9mm (3/8")  
Strap: 50mm



BLACK



**BIG WAVE 12'0**

LP12XT

When size matters - If a set comes, let's face it... You're gonna GO!

Wave Size: 18ft+ (5.5m+)  
Cord Ø: 10mm (13/32")  
Strap: 50mm



BLACK



**BIG WAVE 15'0**

LP15XT

Built for the whatever the ocean has to throw at you!

Wave Size: 18ft+ (5.5m+)  
Cord Ø: 10mm (13/32")  
Strap: 50mm

A full-page photograph of a surfer in a dark wetsuit riding a longboard on a wave. The surfer is positioned in the center-left of the frame, leaning forward. The wave is breaking to the left, creating white spray. The water is a vibrant turquoise color. The sky is a pale, clear blue. The overall mood is dynamic and energetic.

**ONE XT**  
**LONGBOARD**

LONGBOARD ONE - XT



**ONE XT**  
**LONGBOARD PREMIUM 9'0**

LP90XT

All-round longboard leash with a longer railsaver.

Wave Size: 8ft (2.4m)  
Cord Ø: 7mm (9/32")  
Strap: 50mm  
Railsaver: Extra Long



**ONE XT**  
**LONGBOARD KNEE COMP 9'0**

LKC90XT

Lightweight leash, knee style perfect for hanging the toes over the nose.

Wave Size: 4ft (1.2m)  
Cord Ø: 6mm (1/4")  
Strap: 38mm Knee  
Railsaver: Extra Long



**ONE XT**  
**LONGBOARD KNEE PREMIUM 9'0**

LK90XT

If you can hang your toes over the nose use a knee strap. Tangle-free.

Wave Size: 4ft (1.2m)  
Cord Ø: 7mm (9/32")  
Strap: 38mm Knee  
Railsaver: Extra Long

A wide-angle photograph of a surfer riding a large, curling wave. The surfer is positioned in the center of the wave's barrel, wearing a dark wetsuit. The wave is a vibrant green color, and the water is splashing white foam. The background shows a vast expanse of blue ocean under a clear sky. In the foreground, there is a blurred, out-of-focus area of brownish vegetation, likely grass or reeds, which adds depth to the scene.

# DIAMOND FLEX

A D V A N C E D M O U L D E D D E S I G N

Advanced mould design with flex diamonds provides controlled flex. Designed to stretch with the urethane cord.

WARRANTY 12 MONTHS WARRANTY

12  
MONTHS

Guaranteed against faulty workmanship or defective materials for 12 months from date of purchase.

DIAMOND FLEX MOULD

Advanced mould design with flex diamonds. Provides controlled flex and strong transition from mould to urethane.

ORIGINAL DETACHABLE RAILS AVER

The original railsaver system designed by O&E, with sewn in anchor cord. Protects rails and is easily detached.

PLUG BUDDY

Another O&E first. Ensures leash string can be easily slipped through surfboard plug.

8MM DUAL ANCHOR STEEL SWIVELS

Marine grade, stainless anti-corrosive free-spin swivels for tangle-free surfing.

ANTI-SLIP STRAP

Textured non-slip neoprene, positioned on the inside of the ankle strap. Minimises strap movement.

FLEX NECK STRAP PLUG

Allows 360° movement of leash and offers more comfort when leash is under load.

DELUXE ANKLE STRAP

Double padded comfort strap. Lightweight, secure fit.

CONTROLLED-STRETCH URETHANE

Premium grade quality urethane developed by the world's leading manufacturer.

DIAMOND-FLEX Mould - Unstressed

DIAMOND-FLEX Mould - Stretched to 5x it's original length.





BLUE



LIME

**GROMMET**

**DIAMOND FLEX**  
**GROMMET 5'0**

**LM50**

Wave Size: 3ft (1.0m)  
Cord Ø: 6mm (1/4")  
Strap: 38mm

DIAMOND FLEX



DIAMOND FLEX  
COMP 6'0

LM60

Wave Size: 4ft (1.2m)  
Cord Ø: 6mm (1/4")  
Strap: 38mm



DIAMOND FLEX  
REGULAR 6'0

LR60

Wave Size: 6ft (1.8m)  
Cord Ø: 7mm (9/32")  
Strap: 38mm



DIAMOND FLEX  
REGULAR 7'0

LR70

Wave Size: 8ft (2.4m)  
Cord Ø: 7mm (9/32")  
Strap: 50mm



DIAMOND FLEX  
REGULAR 8'0

LR80

Wave Size: 10ft (3.0m)  
Cord Ø: 7mm (9/32")  
Strap: 50mm

DIAMOND FLEX



**DIAMOND FLEX  
LONGBOARD REG 9'0**

LR90

Wave Size: 6ft (1.8m)  
Cord Ø: 7mm (9/32")  
Strap: 50mm



**DIAMOND FLEX  
LONGBOARD KNEE 9'0**

LRK90

Wave Size: 3ft (1.0m)  
Cord Ø: 7mm (9/32")  
Strap: 38mm Knee Strap



**DIAMOND FLEX  
SUP/LONGBOARD REG 8'0**

LSR8

Wave Size: SUP: 3ft (1.0m)  
Longboard: 6ft (1.8m)  
Cord Ø: 8mm (1/3")  
Strap: 50mm



**DIAMOND FLEX  
SUP/LONGBOARD REG 9'0**

LSR9

Wave Size: SUP: 4ft (1.2m)  
Longboard: 7ft (2.0m)  
Cord Ø: 8mm (1/3")  
Strap: 50mm

DIAMOND FLEX



DIAMOND FLEX  
SUP/LONGBOARD REG 10'0"

LSR10

Wave Size: SUP: 5ft (1.5m)  
Longboard: 8ft (2.4m)  
Cord Ø: 8mm (1/3")  
Strap: 50mm



DIAMOND FLEX  
SUP COIL REG 9'0"

LSC90

Designed for flat water paddling

Length: Coiled: 2'6" (0.76m)  
Extended: 10'0" (3m)  
Cord Ø: 8mm (1/3")  
Strap: 50mm



DIAMOND FLEX  
SUP COIL KNEE 9'0"

LSK90

Designed for flat water paddling

Length: Coiled: 2'6" (0.76m)  
Extended: 10'0" (3m)  
Cord Ø: 8mm (1/3")  
Strap: 38mm Knee Strap



# SUNSET

## DIAMOND FLEX MOULDED DESIGN

Diamond-Flex moulds, stainless steel swivel and premium grade urethane.



### PREMIUM GRADE URETHANE

Premium grade, quality urethane developed by the world's leading manufacturer.

### STAINLESS STEEL SWIVEL

Marine grade, stainless steel anti-corrosive free-spin swivel for tangle-free surfing.

### ORIGINAL DETACHABLE RAILSAYER

The original railsaver system designed by O&E, with sewn in anchor cord. Protects rails and is easily detached.



### DIAMOND FLEX

Advanced mould design with flex diamonds. Provides controlled flex and strong transition from mould to urethane.

### PADDED STRAP

Single, padded comfort strap. Lightweight, secure fit.

WARRANTY  
**12**  
MONTHS

### WARRANTY

Guaranteed against faulty workmanship or defective materials for 12 months from date of purchase.

SUNSET



DIAMOND FLEX  
SUNSET 6'0

LS 60

Wave Size: 5ft (1.5m)  
Cord Ø: 7mm (9/32")  
Strap: 38mm



DIAMOND FLEX  
SUNSET 7'0

LS 70

Wave Size: 6ft (1.8m)  
Cord Ø: 7mm (9/32")  
Strap: 38mm



DIAMOND FLEX  
SUNSET 8'0

LS 80

Wave Size: 7ft (2.1m)  
Cord Ø: 7mm (9/32")  
Strap: 38mm



DIAMOND FLEX  
SUNSET 9'0

LS 90

Wave Size: 7ft (2.1m)  
Cord Ø: 7mm (9/32")  
Strap: 38mm



## BOARDCOVERS

The 2026-27 surfboard cover range – APEX, HYPA & COR\_X a perfect blend of protection, refined shapes and innovation. Elevate your surfboard care with sleek designs that not only protect your boards from the elements, but also add a touch of sophistication. Our covers are crafted with cutting-edge materials for maximum durability, ensuring your boards stay in top condition. Embrace the future of surfboard protection with our innovative range that redefines the way you care for your boards, instilling trust for a lifetime, so you can hit the waves with peace of mind.

## APEX

PATENT APPLIED

The pinnacle of durability and innovation.  
Surf with no limits.

Embrace the future of surfboard protection with our innovative APEX 'XPS-IPS' protection systems, incorporating a structured external shell (XPS) for high-impact defence and internally positioned cushioning pads and compression straps (IPS) designed to cradle and safeguard your boards, instilling a lifetime of trust, so you can hit the waves with total peace of mind.

## HYP A

Performance meets design.  
Surf at the next level.

Introducing our HYP A surfboard travel cover range, meticulously crafted with (XP) extra protection for the nose, tail, and rail. Featuring refined shapes that not only embody performance design, but also ensure trusted and reliable protection for your quiver of boards.

## COR\_X

Quality you can trust.  
Surf with confidence.

Quality surfboard cover at great value with all the important features to keep your beloved surf boards safe. Your everyday cover.



Australian Surf Industry Awards

WINNER | WINNER

SURFING ACCESSORY OF THE YEAR (X2) | PRODUCT INNOVATION AWARD



COMMITTED TO PLASTIC REDUCTION

This product range comes with plastic free packaging.  
Another step in the right direction to help eliminate single use plastic.



# SUSTAINABILITY.

At Ocean & Earth, we're dedicated to protecting our planet.

Our board cover range is designed for a lifetime of use, and our lifetime warranty underscores our commitment to a sustainable future, reducing waste and keeping the Ocean & Earth pumping for generations to come.



# LIFETIME WARRANTY.

**We back the quality of our products and assure you against faulty workmanship or defective materials for the entire lifespan of the product. You're covered with repair, replacement or refund choices.**

**While wear and tear damage isn't covered, we're here to assist with repairs at a fair and reasonable fee. Your satisfaction remains our top priority.**

\* LIFETIME WARRANTY APPLIES TO 2026-27 BOARDCOVER RANGE:  
APEX, HYPA AND COR\_X PRODUCTS ONLY

**APEX**

The APEX of protection for a lifetime of travel.



Australian Surf Industry Awards | WINNER | SURFING ACCESSORY OF THE YEAR (X2)  
WINNER | PRODUCT INNOVATION AWARD



Surf with no limits

PATENT APPLIED



APEX

**XPS**

**EXTRA PROTECTION SYSTEM**

Structured outer shell. Strategically positioned at nose, tail and rails to protect against high impacts.

**ARMOUR PLATE**

Tough, tear proof, water repellent fabric

**ANTI-IMPACT MOULDED FOAM**

Cushions your boards from high impacts  
(nose/tail)

**HIGH IMPACT INNER BOARD**

Stiff board stops impacts  
(nose/tail/rail)

# APEX

## EXTERNAL FEATURES

PATENT APPLIED

PATENT APPLIED



### YPS EXTRA PROTECTION SYSTEM

Structured outer shell. Strategically positioned at nose, tail and rails to protect against high impacts.



### AIRCON VENT

The integrated vent enhances breathability and regulates temperature to prolong your board's life.



### CUSTOM WHEEL SYSTEM

Heavy duty inline bearing system. Positioned on the end of the cover for easy dragging or stand the cover upright to roll into lifts.

\*Selected styles only



### EXTERNAL COMPRESSION STRAPS

Minimises board movement in transit

\*Selected styles only



### ANTI SHOCK SHOULDER STRAP

The stretchy shoulder strap offers flexibility and comfort, adjusting effortlessly to your movements.



### TOP LOAD HANDLES

Strategically positioned handles to help baggage handlers move your prized possessions with ease through the airport.



### SKID PLATE

Durable layer on the bottom, designed to reduce abrasion and protect the cover and surfboards during transport.



### HEAVY DUTY, LOCKABLE ZIPPERS

### ERGONOMIC CARRY HANDLE

### SHOULDER STASH POCKET

### ARMOURWEAVE. LIGHT, TEAR-PROOF FABRIC

# iPS

## INTERNAL PROTECTION SYSTEM

Strategically positioned cushioning pads and compression straps designed to cradle and protect your boards.

### NOSE PADS

Strategically positioned cushioning pads redirects the stress away from the fragile point of your nose.

### SURFBOARD CRADLE PADDED DIVIDER

Strategically positioned cushioning pads designed to cradle and protect your boards.

### NOSE + TAIL PADDED BUMPERS

Forget about bubble wrap. Extra padding to further protect the most fragile parts of your boards.



PATENT APPLIED

INTERNAL FEATURES



**iPS NOSE CUSHIONING PADS**

Strategically positioned cushioning pads redirects the stress away from the fragile point of your nose.



**iPS BOARD CRADLE PADDED DIVIDER**

Strategically positioned cushioning pads designed to cradle and protect your boards.



**iPS PADDED INTERNAL COMPRESSION STRAPS**

Minimises board movement whilst in transit: boards arrive at the destination the same way you packed them.



**iPS NOSE + TAIL PADDED BUMPERS**

Forget about bubble wrap. Extra padding to further protect the most fragile parts of your boards



**AIRCON VENT (INTERNAL)**

The integrated vent enhances breathability and regulates temperature to prolong your boards life.



**PADDED FIN POUCHES**

Positioned in the rail of the cover. Each pouch has separate sections, so your fins don't touch each other.



**AIRTAG POCKET**

Know exactly where your gear is with the Airtag pocket.



**HANGING HOOK**

Patented removable hanging hook. Hang cover with ease.



**LIGHTWEIGHT LINING**

Water repellent, internal lining.

# APEX

## The pinnacle of durability & innovation. Surf with no limits.

Embrace the future of surfboard protection with our innovative APEX 'XPS-IPS' protection systems, incorporating a structured external shell (XPS) for high-impact defence and internally positioned cushioning pads and compression straps (IPS) designed to cradle and safeguard your boards, instilling a lifetime of trust, so you can hit the waves with total peace of mind.





BLACK

## APEX

### SHORTBOARD TRAVEL COVER

#### 2 BOARD

SCSB02-A

COLOURS ■ Black

BOARD SIZE	WEIGHT
6'0	4.38 kgs
6'4	4.47 kgs
6'8	4.62 kgs
7'0	4.77 kgs

Fits boards up to 21 1/2" wide



BLACK

## APEX

### SHORTBOARD TRAVEL COVER

#### 3 BOARD

SCSB03-A

COLOURS ■ Black

BOARD SIZE	WEIGHT
6'0	5.15 kgs
6'4	5.35 kgs
6'8	5.53 kgs
7'0	5.67 kgs

Fits boards up to 21 1/2" wide

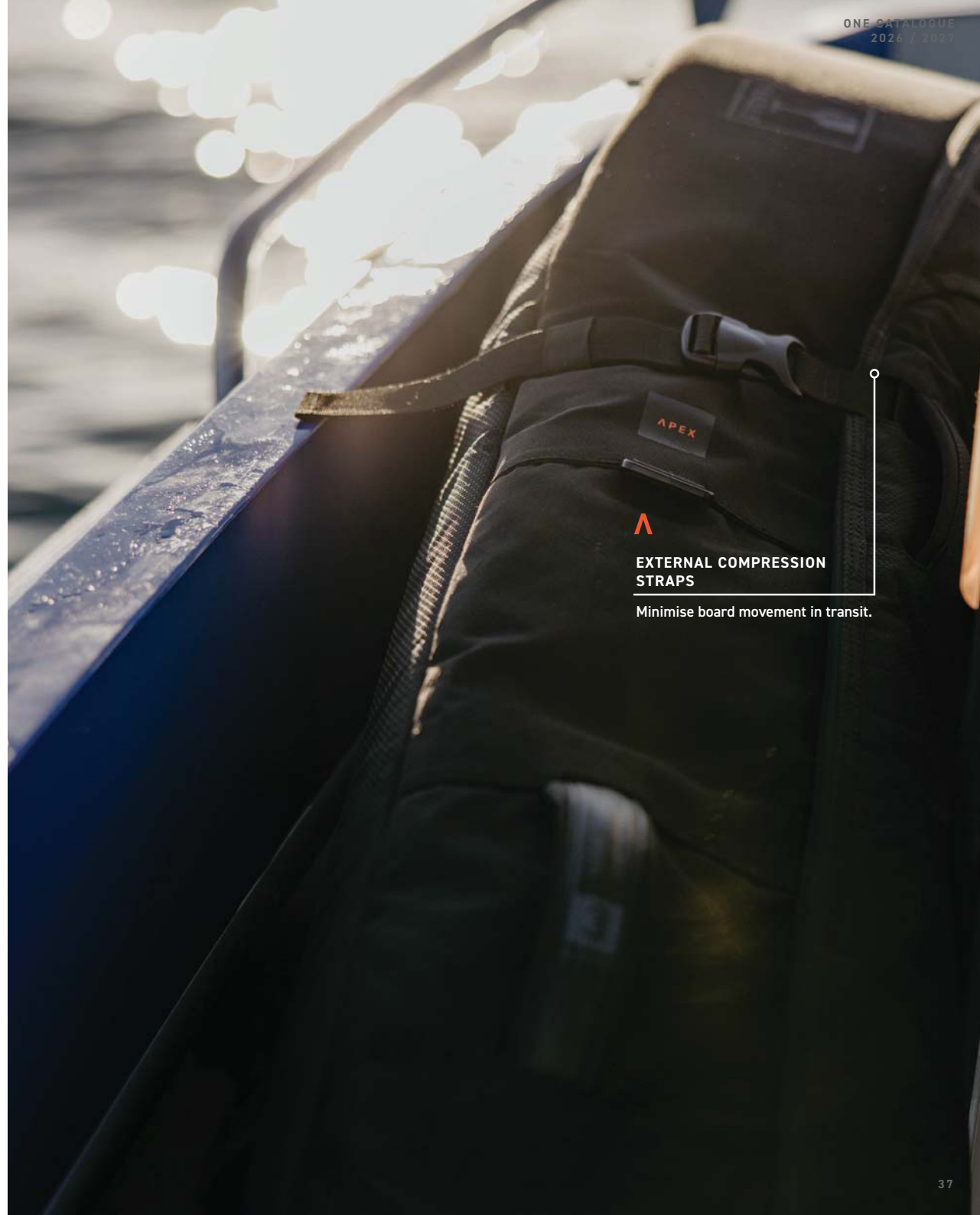

#### EXTERNAL COMPRESSION STRAPS

Minimise board movement in transit.

## APEX FISH/SHORTBOARD

A compact cover designed to protect multiple fish/shortboards. 1 1/2" wider than the APEX shortboard travel cover.

**IPS**

### INTERNAL PROTECTION SYSTEM

Strategically positioned cushioning pads and compression straps designed to cradle and protect your boards.





BLACK

## APEX

FISH / SHORT TRAVEL COVER

2 BOARD

SCFS02-A

COLOURS ■ Black

BOARD SIZE	WEIGHT
6'0	5.02 kgs
6'4	5.15 kgs
6'8	5.30 kgs
7'0	5.43 kgs
7'6	5.62 kgs

Fits boards up to 22 1/2" wide



BLACK

## APEX

FISH / SHORT TRAVEL COVER

3 BOARD

SCFS03-A

COLOURS ■ Black

BOARD SIZE	WEIGHT
6'0	5.94 kgs
6'4	6.16 kgs
6'8	6.34 kgs
7'0	6.54 kgs
7'6	6.62 kgs
8'0	6.70 kgs

Fits boards up to 22 1/2" wide



BLACK

## APEX

FISH / SHORT TRAVEL COVER

4 BOARD

SCFS04-A

COLOURS ■ Black

BOARD SIZE	WEIGHT
6'0	<b>NEW</b> 7.00 kgs
6'4	7.19 kgs
6'8	7.44 kgs
7'0	7.64 kgs
7'6	7.72 kgs

Fits boards up to 22 1/2" wide



BLACK

## APEX

FISH / SHORT TRAVEL COVER

5 BOARD

SCFS05-A

COLOURS ■ Black

BOARD SIZE	WEIGHT
6'4	<b>NEW</b> 8.17 kgs
6'8	8.37 kgs
7'0	8.57 kgs

Fits boards up to 22 1/2" wide



## APEX WHEEL

Save your shoulders for the waves and let the wheels do the work. This cover has enough space to protect your entire quiver, plus all your surf trip essentials.

### CUSTOM WHEEL SYSTEM

Heavy duty inline bearing system. Positioned on the end of the cover for easy dragging or stand the cover upright to roll into lifts.



BLACK

## APEX

FISH / SHORT TRAVEL COVER  
3 BOARD - WHEEL

SCFS03W-A

COLOURS ■ Black

BOARD SIZE	WEIGHT
6'0 <b>NEW</b>	6.62 kgs
6'4	6.81 kgs
6'8	6.95 kgs
7'0	7.16 kgs
7'6	7.37 kgs

Fits boards up to 22 1/2" wide



BLACK

## APEX

FISH / SHORT TRAVEL COVER  
4 BOARD - WHEEL

SCFS04W-A

COLOURS ■ Black

BOARD SIZE	WEIGHT
6'0 <b>NEW</b>	7.59 kgs
6'4	7.79 kgs
6'8	8.03 kgs
7'0	8.20 kgs
7'6	8.43 kgs

Fits boards up to 22 1/2" wide



BLACK

## APEX

FISH / SHORT TRAVEL COVER  
5 BOARD - WHEEL

SCFS05W-A

COLOURS ■ Black

BOARD SIZE	WEIGHT
6'4 <b>NEW</b>	9.07 kgs
6'8 <b>NEW</b>	9.26 kgs

Fits boards up to 22 1/2" wide



BLACK

## APEX

FISH / SHORT TRAVEL COVER  
6 BOARD - WHEEL

SCFS06W-A

COLOURS ■ Black

BOARD SIZE	WEIGHT
6'4 <b>NEW</b>	9.89 kgs
6'8 <b>NEW</b>	10.07 kgs

Fits boards up to 22 1/2" wide



BLACK

## APEX

LONGBOARD TRAVEL COVER  
2 BOARD - WHEEL

SCLB02W-A

COLOURS ■ Black

BOARD SIZE	WEIGHT
8'6 <b>NEW</b>	7.47 kgs
9'6 <b>NEW</b>	7.92 kgs

Fits boards up to 25" wide

# APEX

## The pinnacle of durability & innovation. Surf with no limits.

Embrace the future of surfboard protection with our innovative APEX XPS protection system, featuring a structured external shell (XPS) for high-impact defence. The zip-out tail gusset allows for secure closure during travel, safeguarding 1 board with or without fins.

### XPS (NOSE)

- +ARMOUR PLATE
- +ANTI-IMPACT MOULDED FOAM

### ARMOUR WEAVE [LITE]

Lightweight tough, tear proof, water repellent fabric.

### ANTI-SHOCK FOAM

10mm shock absorbing foam.

### LIGHTWEIGHT LINING (INTERNAL)

Water repellent, internal lining.

### XPS (TAIL)

- +ARMOUR PLATE
- +ANTI-IMPACT MOULDED FOAM



### ARMOUR PLATE

Lightweight tough, tear proof, water repellent fabric.

### AIRCON VENT

The integrated vent enhances breathability and regulates temperature to prolong your boards life.

### DETACHABLE SHOULDER STRAP

Double thick padded shoulder strap for comfort.

### FULL RAIL GUSSET

Runs around the entire cover for a compact fit.

### EXPANDABLE TAIL GUSSET

Zip closure for use with or without fins.

### STORAGE POCKET

An oversize velcro pocket.

### NON-CORROSIVE ZIPPERS

Easy slide Nylon zippers.

### HANGING HOOK

Patented removable hanging hook. Hang cover with ease.



BLACK

## APEX

### SHORTBOARD TRAVEL COVER

#### 1 BOARD

SCSB01 - A

COLOURS ■ Black

BOARD SIZE	WEIGHT
5'8	2.67 kgs
6'0	2.75 kgs
6'4	2.85 kgs
6'8	2.96 kgs
7'0	3.05 kgs
7'4	3.15 kgs

Fits boards up to 21 1/2" wide



BLACK

## APEX

### FISH TRAVEL COVER

#### 1 BOARD

SCFB01 - A

COLOURS ■ Black

BOARD SIZE	WEIGHT
5'8	2.93 kgs
6'0	3.03 kgs
6'4	3.11 kgs
6'8	3.22 kgs
7'0	3.30 kgs
7'4	3.40 kgs
7'8	3.48 kgs

Fits boards up to 22 1/2" wide



BLACK

## APEX

### LONGBOARD TRAVEL COVER

#### 1 BOARD

SCLB01-A

COLOURS ■ Black

BOARD SIZE	WEIGHT
7'0	3.66 kgs
7'6	3.78 kgs
8'0	4.04 kgs
8'6	4.14 kgs
9'2	4.33 kgs
9'6	4.44 kgs
10'0	4.59 kgs

Fits boards up to 25" wide



#### EXTRA PROTECTION SYSTEM

Structured outer shell. Strategically positioned at nose, tail and rails to protect against high impacts.

#### ARMOUR PLATE

Tough, tear proof, water repellent fabric

#### ANTI-IMPACT MOULDED FOAM

Cushions your boards from high impacts (nose/tail)

#### EXPANDABLE TAIL GUSSET

Zip closure for use with or without fins.



**HYP A**

**Performance meets design.  
Surf at the next level.**

Introducing our HYP A surfboard travel cover range, meticulously crafted with (XP) extra protection for the nose, tail, and rail and featuring refined shapes that not only embody performance design but also ensure trusted and reliable protection for your quiver of boards.





## EXTRA PROTECTION

Extra protection in high impact areas:  
nose, tail and rails.



### ARMOURWEAVE

Tough, tear-proof, water-repellent fabric



### ANTI-IMPACT FOAM

Protects your boards from high impacts



### DOUBLE PADDED SIDE WALL (20mm)

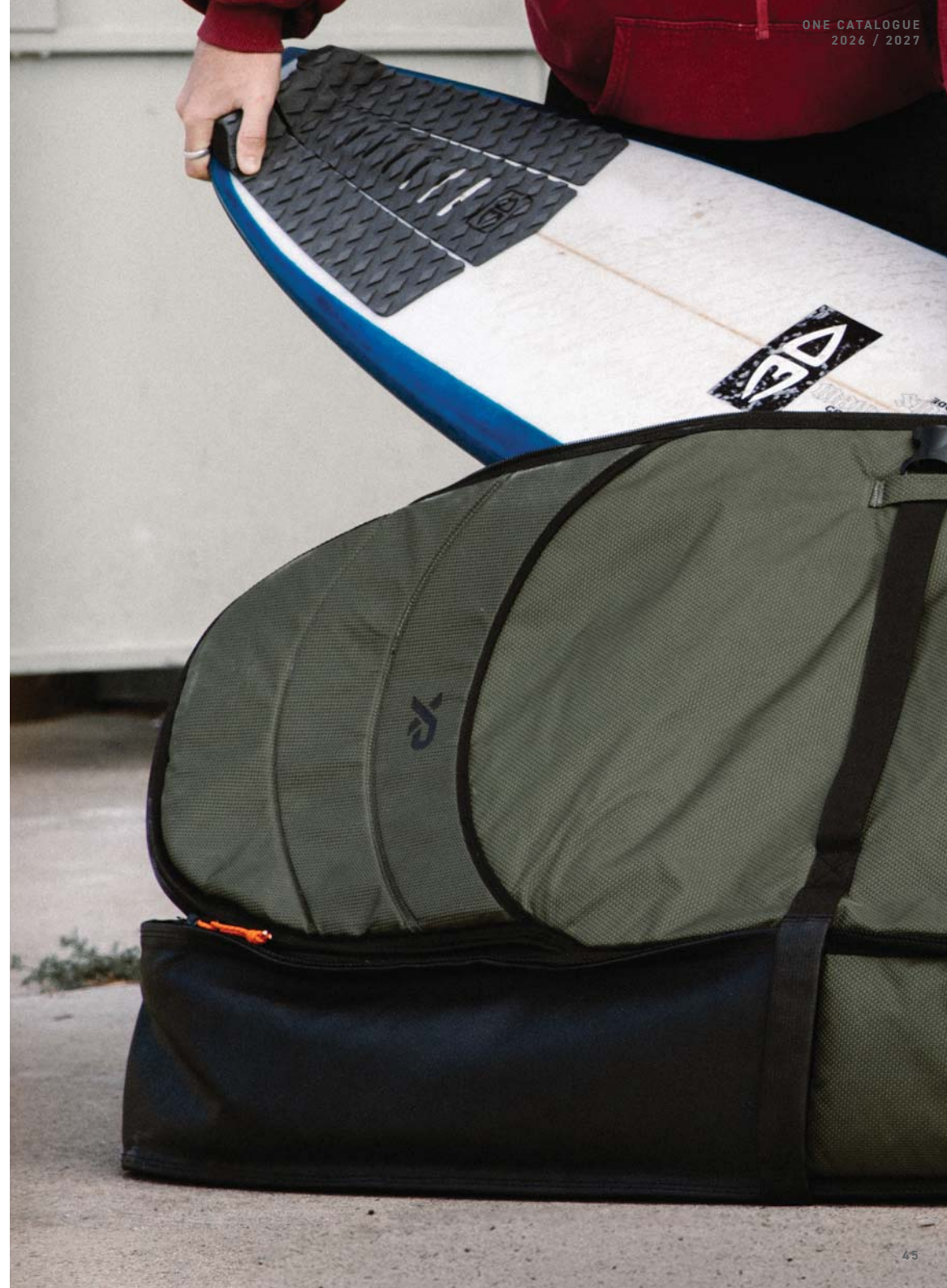

## Performance meets design. Surf at the next level.

A compact fitting cover designed for carrying multiple shortboards. The moulded rubber side wall adds an extra layer of protection. Ideal for domestic or international surf trips.



### ARMOUR WEAVE

Tough, tear proof, water repellent fabric.

### ANTI-IMPACT FOAM

Protects your boards from high impacts.

### ARMOUR WEAVE [LIGHT]

Lightweight, tough, tear proof, water repellent fabric.

### ANTI-SHOCK FOAM

10mm shock absorbing foam.  
All over protection for your boards.

### SHOULDER STRAP

20mm padded detachable strap:  
extra comfort and stashes into pocket.



### ARMOUR WEAVE

Tough, tear proof, water repellent fabric.

### ANTI-IMPACT FOAM

Protects your boards from high impacts.



### MOULDED RUBBER SIDE WALL (20mm)

10mm Anti-Impact foam +  
10mm Anti-Shock foam.

### SEWN IN PADDED DIVIDER

Protects and separates boards plus  
minimises wax transferring.

### INTERNAL COMPRESSION STRAPS

Minimises board movement whilst in  
transit: boards arrive at the destination  
the same way you packed them.

### LIGHTWEIGHT LINING

Water repellent, internal lining.

### HEAVY DUTY ZIPPERS

Large lockable zipper heads.  
Extra security for your boards.

### INTERNAL STORAGE POCKET

An oversize velcro pocket for all of your  
surf accessories.

### HANGING HOOK

Patented removable hanging hook.  
Hang cover with ease.





BLACK



KHAKI

## YPA

### SHORTBOARD TRAVEL COVER

#### 2 BOARD

SCSB02-H

COLOURS ■ Black ■ Khaki

BOARD SIZE	WEIGHT
6'0	3.11kgs
6'4	3.20 kgs
6'8	3.30 kgs
7'0*	3.43 kgs

\*Black only

Fits boards up to 21½" wide

## YPA

### SHORTBOARD TRAVEL COVER

#### 3 BOARD

SCSB03-H

COLOURS ■ Black ■ Khaki

BOARD SIZE	WEIGHT
6'0*	3.60 kgs
6'4	3.72 kgs
6'8	3.85 kgs
7'0*	4.05 kgs

\*Black only

Fits boards up to 21 ¼" wide



MOULDED RUBBER SIDE WALL (20mm)

10mm Anti-Impact foam +  
10mm Anti-Shock foam.

## Performance meets design. Surf at the next level.

A cover with enough space to take your entire quiver, plus all your surf trip essentials. The thick, double padded side wall and external expander straps will protect boards by minimising movement.



### ARMOUR WEAVE

Tough, tear proof, water repellent fabric.

### ANTI-IMPACT FOAM

Protects your boards from high impacts.

### EXTERNAL COMPRESSION STRAPS

Minimises board movement whilst in transit.

### ARMOUR WEAVE [LIGHT]

Lightweight, tough, tear proof, water repellent fabric.

### ANTI-SHOCK FOAM

10mm shock absorbing foam. All over protection for your boards.

### SHOULDER STRAP

20mm padded detachable strap: extra comfort and stashes into pocket.



### ARMOUR WEAVE

Tough, tear proof, water repellent fabric.

### ANTI-IMPACT FOAM

Protects your boards from high impacts.



### DOUBLE PADDED SIDE WALL (20mm)

2 X 10mm layers of Anti-Shock foam.

### SEWN IN PADDED DIVIDER

Protects and separates boards plus minimises wax transferring.

### INTERNAL COMPRESSION STRAPS

Minimises board movement whilst in transit: boards arrive at the destination the same way you packed them.

### LIGHTWEIGHT LINING

Water repellent, internal lining.

### HEAVY DUTY ZIPPERS

Large lockable zipper heads. Extra security for your boards.

### INTERNAL STORAGE POCKET

An oversize velcro pocket for all of your surf accessories.

### HANGING HOOK

Patented removable hanging hook. Hang cover with ease.





BLACK



KHAKI



BLACK



BLACK



BLACK

## »YPA

### FISH / SHORT TRAVEL COVER 2 BOARD

SCFS02-H

COLOURS ■ Black ■ Khaki

BOARD SIZE	WEIGHT
6'0*	3.47 kgs
6'4	3.55 kgs
6'8	3.74 kgs
7'0	3.85 kgs
7'6	4.02 kgs
8'0*	4.20 kgs

\*Black only

Fits boards up to 22 1/2" wide

## »YPA

### FISH / SHORT TRAVEL COVER 3 BOARD

SCFS03-H

COLOURS ■ Black ■ Khaki

BOARD SIZE	WEIGHT
6'0*	4.14 kgs
6'4	4.22 kgs
6'8	4.42 kgs
7'0	4.59 kgs
7'6	4.78 kgs
8'0*	5.03 kgs

\*Black only

Fits boards up to 22 1/2" wide

## »YPA

### FISH / SHORT TRAVEL COVER 4 BOARD

SCFS04-H

COLOURS ■ Black

BOARD SIZE	WEIGHT
6'0* <b>NEW</b>	3.55 kgs
6'4 <b>NEW</b>	3.75 kgs
6'8	4.99 kgs
7'0	5.19 kgs
7'6	5.54 kgs
8'0	5.74 kgs

Fits boards up to 22 1/2" wide

## »YPA

### FISH / SHORT TRAVEL COVER 5 BOARD

SCFS05-H

COLOURS ■ Black

BOARD SIZE	WEIGHT
6'4 <b>NEW</b>	5.35 kgs
6'8	5.55 kgs

Fits boards up to 22 1/2" wide

## »YPA

### LONGBOARD TRAVEL COVER 2 BOARD

SCLB02-H

COLOURS ■ Black

BOARD SIZE	WEIGHT
8'6	5.58 kgs
9'6	6.02 kgs
10'6	6.29 kgs

Fin Slot  
Full Padded Divider

Fits boards up to 24" wide



**YPA**

## Performance meets design. Surf at the next level.

Save your shoulders for the waves and let the wheels do the work. This cover has enough space to take your entire quiver, plus all your surf trip essentials. The thick, double padded side wall and external expander straps will protect boards by minimising movement.

### DOUBLE PADDED SIDE WALL (20mm)

2 X 10mm layers of Anti-Shock foam.

### CUSTOM WHEEL SYSTEM

Heavy duty inline bearing system. Positioned on the end of the cover for easy dragging or stand the cover upright to roll into lifts.



KHAKI

»YPA

FISH / SHORT TRAVEL COVER  
3 BOARD - WHEEL

SCFS03W-H

COLOURS ■ Black ■ Khaki

BOARD SIZE	WEIGHT
6'0*	5.0 kgs
6'4	5.18 kgs
6'8	5.34 kgs
7'0	5.63 kgs
7'6*	5.75 kgs

\*Black only

Fits boards up to 22 1/2" wide



BLACK

»YPA

FISH / SHORT TRAVEL COVER  
4 BOARD - WHEEL

SCFS04W-H

COLOURS ■ Black

BOARD SIZE	WEIGHT
6'0	5.71 kgs
6'4	5.90 kgs
6'8	6.04 kgs
7'0	6.22 kgs
7'6	6.49 kgs
8'0	6.8 kgs

Fits boards up to 22 1/2" wide



BLACK

»YPA

FISH / SHORT TRAVEL COVER  
5 BOARD - WHEEL

SCFS05W-H

COLOURS ■ Black

BOARD SIZE	WEIGHT
6'4	6.50 kgs
6'8	6.76 kgs

Fits boards up to 22 1/2" wide



BLACK

»YPA

LONGBOARD TRAVEL COVER  
2 BOARD - WHEEL

SCLB02W-H

COLOURS ■ Black

BOARD SIZE	WEIGHT
8'6	6.63 kgs
9'6	7.14 kgs

Fin Slot  
Full Padded Divider

Fits boards up to 24" wide



**YPA**

## Performance meets design. Surf at the next level.

A compact fitting cover with an expandable side wall. The velcro tabs on tail gusset can be secured shut for use with or without fins. Ideal for day-to-day surf trips.



### ARMOUR WEAVE

Tough, tear proof, water repellent fabric.

### ANTI-IMPACT FOAM

Protects your boards from high impacts.

### ARMOUR WEAVE [LIGHT]

Lightweight, tough, tear proof, water repellent fabric.

### ANTI-SHOCK FOAM

5mm shock absorbing foam.  
All over protection for your boards.

### SHOULDER STRAP

20mm padded detachable strap:  
extra comfort and stashes into pocket.



### ARMOUR WEAVE

Tough, tear proof, water repellent fabric.

### ANTI-IMPACT FOAM

Protects your boards from high impacts.

### HEAVY DUTY ZIPPERS

Large lockable zipper heads.  
Extra security for your boards.



### ARMOUR WEAVE

Tough, tear proof, water repellent fabric.  
(Nose, Tail, Rails)

### EXPANDABLE SIDE WALL

Runs around the entire cover for a perfect fit.  
Velcro closure for use with or without fins.

### LIGHTWEIGHT LINING

Water repellent, internal lining.

### INTERNAL STORAGE POCKET

An oversize velcro pocket for all of your surf accessories.

### HANGING HOOK

Patented removable hanging hook.  
Hang cover with ease.



BLACK

## »YPA

### SHORTBOARD DAY COVER

#### 1 BOARD

SCSB01-H

COLOURS ■ Black ■ Khaki

BOARD SIZE	WEIGHT
5'8"	1.68 kgs
6'0	1.77 kgs
6'4	1.79 kgs
6'8	1.90 kgs
7'0*	1.96 kgs

\*Black only

Fits boards up to 21 1/4" wide



KHAKI

## »YPA

### FISH DAY COVER

#### 1 BOARD

SCFB01-H

COLOURS ■ Black ■ Khaki

BOARD SIZE	WEIGHT
5'8"	1.85 kgs
6'0	1.92 kgs
6'4	1.99 kgs
6'8	2.04 kgs
7'0	2.14 kgs
7'4	2.22 kgs
7'8*	2.30 kgs

\*Black only

Fits boards up to 22 1/2" wide



BLACK

## »YPA

### MID LENGTH DAY COVER

#### 1 BOARD

SCML01-H

COLOURS ■ Black

BOARD SIZE	WEIGHT
6'8	1.96 kgs
7'0	2.05 kgs
7'4	2.12 kgs
7'8	2.20 kgs
8'0	2.29 kgs

- Fin Slot

Fits boards up to 22 1/2" wide



KHAKI

## »YPA

### LONGBOARD DAY COVER

#### 1 BOARD

SCLB01-H

COLOURS ■ Black ■ Khaki

BOARD SIZE	WEIGHT
7'0*	2.46 kgs
7'6*	2.56 kgs
8'0	2.66 kgs
8'6	2.76 kgs
9'2	2.97 kgs
9'6	3.05 kgs
10'0*	3.16 kgs
10'6*	3.27 kgs
11'0*	3.39 kgs

\*Black only

- Fin Slot

Fits boards up to 24" wide



BLACK

## »YPA

### BIG WAVE DAY COVER

#### 1 BOARD

SCBW01-H

COLOURS ■ Black

BOARD SIZE	WEIGHT
8'0	2.37 kgs
8'6	2.47 kgs
9'6	2.66 kgs
11'0	2.91 kgs

- 5mm foam

- 10mm foam body

- No Expandable Side Wall

- Zip Out Tail Gusset

Fits boards up to 22" wide



## COR\_X

### Quality you can trust. Surf with confidence

Quality surfboard cover at great value with all the important features to keep your beloved surfboards safe. Your everyday cover.

#### ARMOUR\_X WEAVE

Impact resistant, tear proof, nylon fabric.

#### NYLON RIPSTOP

Lightweight, tough, water repellent fabric.

#### ANTI-SHOCK FOAM

5mm shock absorbing foam. (10mm in 2-Board cover)  
All over protection for your boards.

#### LIGHTWEIGHT INTERNAL LINING

Water repellent, internal lining.

#### HEAVY DUTY ZIPPERS

Large, non-corrosive nylon zippers

#### SHOULDER STRAP

Detachable 38mm shoulder strap. 20mm padded  
on Longboard, SUP & Fish/shortboard double.

#### INTERNAL STORAGE POCKET

An oversize velcro pocket for all of  
your surf accessories.

#### HANGING HOOK

Patented removable hanging hook.  
Hang cover with ease.





BLACK

## COR\_X

### SHORTBOARD DAY COVER

#### 1 BOARD

SCSB01-C

COLOURS ■ Black

BOARD SIZE	WEIGHT
5'4	0.99 kgs
5'8	1.14 kgs
6'0	1.19 kgs
6'4	1.26 kgs
6'8	1.31 kgs

Fits boards up to 21" wide



BLACK

## COR\_X

### FISH DAY COVER

#### 1 BOARD

SCFB01-C

COLOURS ■ Black

BOARD SIZE	WEIGHT
5'4	1.22 kgs
5'8	1.30 kgs
6'0	1.33 kgs
6'4	1.39 kgs
6'8	1.48 kgs
7'0	1.51 kgs
7'6	1.61 kgs
8'0	1.75 kgs

Fits boards up to 23 1/2" wide



BLACK

## COR\_X

### LONGBOARD DAY COVER

#### 1 BOARD

SCLB01-C

COLOURS ■ Black

BOARD SIZE	WEIGHT
7'0	1.63 kgs
7'6	1.71 kgs
8'0	1.74 kgs
8'6	1.80 kgs
9'2	1.90 kgs
9'6	1.96 kgs
10'0	2.03 kgs
10'6	2.10 kgs

Fits boards up to 24" wide  
- Fin Slot  
- Padded Carry Strap



BLACK

## COR\_X

### FISH / SHORT TRAVEL COVER

#### 2 BOARD

SCFS02-C

COLOURS ■ Black

BOARD SIZE	WEIGHT
6'0	1.95 kgs
6'4	2.03 kgs
6'8	2.11 kgs

- 10mm Foam  
- Padded Carry Strap

Fits boards up to 22 1/2" wide



X

## STRETCH COVERS



# COR\_X

**Quality you can trust.  
Surf with confidence**

Lightweight protection. Made from high quality, thick polyester stretch fabric. Protective nose piece and drawstring closure.

### UPDATED NOSE PIECE

Tough nylon polyester



### STRETCH FABRIC

Extra thick polyester

### TAIL CLOSURE

Drawcord with toggle



## COR\_X SHORTBOARD STRETCH COVER

SCSB01S-C

Cols: ■ Khaki ■ Lt Grey

- SIZE**
- 5'8" \_\_\_\_\_
  - 6'0" \_\_\_\_\_
  - 6'6" \_\_\_\_\_
  - 7'0" \_\_\_\_\_
  - 7'6" \_\_\_\_\_

\* Khaki only

## COR\_X FISH STRETCH COVER

SCFB01S-C

Cols: ■ Khaki ■ Lt Grey

- SIZE**
- 5'8" \_\_\_\_\_
  - 6'0" \_\_\_\_\_
  - 6'6" \_\_\_\_\_
  - 7'0" \_\_\_\_\_
  - 7'6" \_\_\_\_\_

## COR\_X LONGBOARD STRETCH COVER

SCLB01S-C

Cols: ■ Khaki ■ Lt Grey

- SIZE**
- 7'0" \_\_\_\_\_
  - 7'6" \_\_\_\_\_
  - 8'0" \_\_\_\_\_
  - 8'6" \_\_\_\_\_
  - 9'0" \_\_\_\_\_
  - 9'6" \_\_\_\_\_
  - 10'0" \_\_\_\_\_
  - 10'6" \_\_\_\_\_
  - 11'0" \_\_\_\_\_

\* Khaki only

## BOARDCOVER ACCESSORIES

OCEAN + EARTH   
FIN CASE



Folds up to carry size  
390mm wide x 250mm height

### 3-FOLD SURF LOCKER

AMTS26



ARMOUR WEAVE  
- FABRIC -

- Large surf travel pack
  - Ideal for storing all your surf essentials for travel or in car
  - Armour Weave tear-proof fabric with protective foam padding
- \*Accessories not included



Folds up to carry size  
260mm wide x 190mm height

**FIN CASE**  
AMTS30



ARMOUR WEAVE- tear proof fabric  
STORES UP TO 5 SETS OF FINS (S, M, L) or 3 sets of fins plus surf accessories eg. Wax, Wax Comb, Sun Cream, Ding Tape, Solar Resin.

- Lightweight shock absorbing foam
- Internal mesh windows secure with velcro
- Hanging hook

\*Accessories not included



Folds up to carry size  
420mm wide x 180mm height

**FIN POUCH**  
AMTS27

420D NYLON  
STORES UP TO 4 FIN SETS

- Nylon outer fabric with internal PE foam protection
- Mesh breathable windows for easy visibility
- Fits size small / medium / large fins
- Hanging hook
- Velcro strap closure

\*Accessories not included



Folds up to carry size  
420mm wide x 230mm height

**LONGBOARD FIN POUCH**  
AMTS29

420D NYLON  
STORES UP TO 2 LONGBOARD FIN SETS

- Nylon outer fabric with internal PE foam protection
- Mesh breathable windows for easy visibility
- Fits all size fins
- Hanging hook
- Velcro strap closure

\*Fins not included



Use with Ocean & Earth travel cover's lockable zipper heads

**TRAVEL LOCK**  
SARX46

Keep your equipment safe and secure with our compact surf travel lock. This lock was designed to be transported by the U.S. Transportation Security Administration (TSA) and allows the TSA to be able to unlock your bag using special access codes and tools if the need arises for a baggage search. This lock can then be relocked by the TSA with no damage to the lock on your travel bag / board cover.

# TAIL PADS

DRIVE / GRIP / PRECISION

Superior traction designed & developed with our professional team over the past 40 years. Lightweight, high impact, water resistant.

Built for performance.



## TREAD PATTERNS



BRUSHED  
CORDUROY



SQUARE DIAMOND



SQUARE



DIAMOND



MULTI-DIRECTIONAL



FLAT  
BRUSHED



LITE TRAC



This product range comes with plastic free packaging.  
Another step in the right direction to help eliminate single use plastic.

DAKODA WALTERS



#### LIGHTWEIGHT DESIGN

The thinnest base available, without compromising strength or adhesion. Added perforation on some styles reduces weight even more.



#### WATERPROOF EVA

Developed to improve all round performance in our technical grips. CC55 Closed Cell EVA is lighter, waterproof and super thin.



#### BASE FLEX

Base Flex groove at the base of the tail kick helps the grip mould to the board for superior adhesion.



- 25mm POWER Kick
- 25mm POWER Vert
- 36mm POWER Kick (Extra High)
- 37mm POWER Scoop (Extra High)

#### POWER KICK

High density EVA foam wedge inserted into the tail kick resulting in increased control and drive.



#### SUPERIOR ADHESIVE BACKING

3M high grade adhesive formula, developed for EVA offers maximum, long lasting adhesion.



PRO SERIES

# LITE TRAC

LIGHTWEIGHT + RESPONSIVE + THINNER + MOULDED TRACTION

Unique EVA traction that has been compressed and finished with our Multi Directional dotted LiteTrac moulded technology. This unique traction combined with LiteTrac moulded tech will become grippier when wet.

## LIGHTWEIGHT - SIDE PIECES

Pro Design tread pattern with LiteTrac Moulded tech

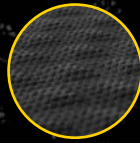

## RESPONSIVE - CENTRE PIECE

Horizontal grooved lines increase the sensitivity between the back foot and board, topped with LiteTrac Moulded tech

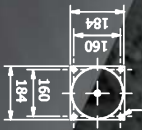

**DAKODA WALTERS**

PRO SERIES  
TP 75

LENGTH: 330mm  
WIDTH: 300mm  
ARCH: 7mm  
KICK: 25mm



3 PIECE  
TRACTION



MULTI-  
DIRECTIONAL  
LITE TRAC



POWER  
KICK



BASE-FLEX



BLACK

LS

**NEW**  
**LENNIX SMITH**

PRO SERIES  
TP79

LENGTH: 305mm  
WIDTH: 300mm  
ARCH: 7mm  
KICK: 30mm

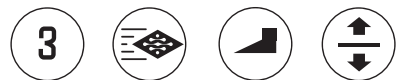

3 PIECE TRACTION MULTI-DIRECTIONAL LITE TRAC POWER VERT TAIL INSERT BASE-FLEX



BLACK

B

**NEW**  
**BRONSON MEYDI**

PRO SERIES  
TP78

LENGTH: 307mm  
WIDTH: 300mm  
ARCH: 7mm  
KICK: 35mm



3 PIECE TRACTION MULTI-DIRECTIONAL ( EXTRA HIGH ) LITE TRAC POWER KICK BASE-FLEX



BLACK

Kanoa

**KANOA IGARASHI**

PRO SERIES  
TP72

LENGTH: 305mm  
WIDTH: 300mm  
ARCH: 7mm  
KICK: 30mm



3 PIECE TRACTION MULTI-DIRECTIONAL ( EXTRA HIGH ) LITE TRAC POWER KICK BASE-FLEX



BLACK

R. Callinan

**RYAN CALLINAN**

PRO SERIES  
TP71

LENGTH: 305mm  
WIDTH: 300mm  
ARCH: 7mm  
KICK: 25mm



3 PIECE TRACTION MULTI-DIRECTIONAL LITE TRAC POWER KICK BASE-FLEX

PRO SERIES





## DAKODA WALTERS TAIL PAD

PRO SERIES  
TP 64

LENGTH: 330mm  
WIDTH: 300mm  
ARCH: 7mm  
KICK: 25mm

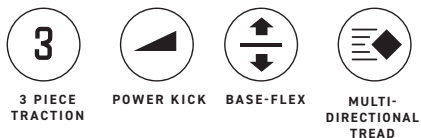

A throw back to the surfing inspired from the 80's and 90's when full coverage was the norm. Kodes's surfing is lightning fast and he spends most of his time above the lip.

Dakoda's signature tail pad has a combination of multi-directional groove patterns. Diamond square on the sides to lock your toes and heel in and brushed corduroy on centre piece with slotted grooves on all three pieces to minimise weight.

IDEAL BOARD: Everyday shortboard

TYPE OF SURFER: Speed / control in the air



BLACK



NEW BEIGE



## DAKODA WALTERS CENTRE DECK

PRO SERIES  
TP 65

LENGTH: 705mm  
WIDTH: 380mm  
ARCH: N/A  
KICK: N/A

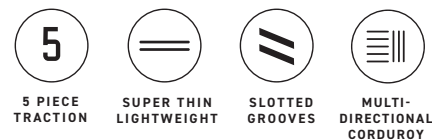

Lightweight and thin multi-directional brushed corduroy minimises rashing, maximises sensitivity between foot and board. When paired together the tail pad and centre deck offers over 1m of spreadable traction

IDEAL BOARD: Everyday shortboard

TYPE OF SURFER: Speed / control in the air

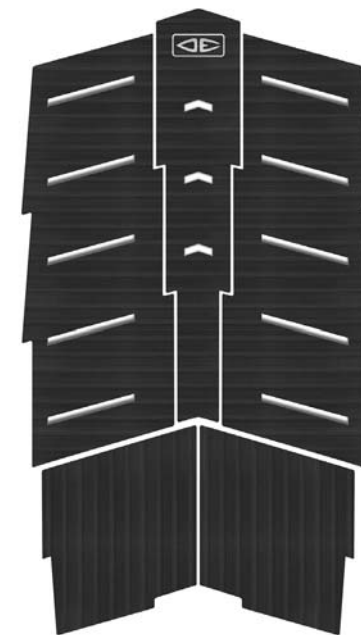

BLACK



*Kanoa*

## KANOA IGARASHI

PRO SERIES  
TP14

LENGTH: 305mm  
WIDTH: 300mm  
ARCH: 7mm  
KICK: 30mm



3 PIECE  
TRACTION



DIAMOND  
SQUARE



POWER KICK  
( EXTRA HIGH )



BASE-FLEX

Kanoa is fast becoming one of the world's premier surfers. Still only young, his surfing is the perfect balance between speed and power.

Die cut slotted grooves in all three pieces minimises weight = more speed. Extra High Power Kick- plant your back foot hard against the kick for more control and drive = more power

This timeless 3 piece outline is the most versatile shape in the range, for a narrower tail keep the pad tight - for a wider tail spread the grip for more coverage.

IDEAL BOARD: Everyday Shortboard

TYPE OF SURFER: Speed and power surfing



WHITE / BLUE



BLACK / CORAL



BLACK / LIME



*R Callin*

**RYAN CALLINAN**

PRO SERIES  
TP 62

LENGTH: 305mm  
WIDTH: 300mm  
ARCH: 7mm  
KICK: 25mm



3 PIECE  
TRACTION



DIAMOND  
GROOVE



POWER  
KICK



BASE-FLEX

R Cal is lightning fast above and below the lip. Everything about Ryan's pad has been designed for speed. Die cut perforations on side pieces and ground down slots on the centre coupled with a slim 25mm Power Kick. Lightweight = Speed. This timeless 3 piece outline is the most versatile shape in the range, for a narrower tail keep the pad tight - for a wider tail spread the grip for more coverage.

IDEAL BOARD: Everyday Shortboard

TYPE OF SURFER: Need for speed / all round surfing



BLUE



LIME



BLACK



WHITE



**NEW**  
**LENNIX SMITH**

PRO SERIES  
TP81

LENGTH: 305mm  
WIDTH: 300mm  
ARCH: 7mm  
KICK: 30mm



3 PIECE  
TRACTION



DIAMOND  
GROOVE



POWER VERT  
TAIL INSERT



BASE-FLEX



BLACK / PLUM



BLACK / MARBLE

Hailing from the wave-rich, slab-heavy South East Coast of Australia, Lennix "The Beagle" Smith is one of Australia's most exciting up-and-coming talents. Regarded for charging dry reef slabs, stacking points in heats, and wearing a trademark cheeky grin, the sky's the limit for The Beagle.

Built to match Lennix's powerful, dynamic surfing, it features a 30mm vertical kick, giving you a solid platform to drive hard off the back foot. The kick has been chamfered to reduce drag through bottom turns, keeping speed and control where it matters most.

The tail profile has been pulled in to mirror modern performance board design, fitting perfectly with squash and round tail shortboards.

IDEAL BOARD: Everyday shortboard  
SURFER TYPE: Speed, power, and all-around performance



NEW

## BRONSON MEYDI

PRO SERIES  
TP80

LENGTH: 307mm  
WIDTH: 300mm  
ARCH: 7mm  
KICK: 35mm



3 PIECE  
TRACTION



DIAMOND  
GROOVE



POWER KICK  
( EXTRA HIGH )



BASE-FLEX



RED / WHITE



BLACK / GOLD

Bronson Meydi has emerged as one of Indonesia's brightest surfing talents, making history as the first Indonesian to win a WSL - World Junior Championship title in 2025. Known for his smooth style, fearless approach, raw power, creative flair, and massive airs.

Engineered for performance, the design features die-cut perforations on the side panels and ground-down slots in the center, paired with a solid 35mm power kick. This combination delivers an ideal balance of lightweight construction, heightened sensitivity, and uncompromising stability.

IDEAL BOARD: Everyday Shortboard

TYPE OF SURFER: Speed / Explosive surfing

**COR\_X**

## SHORTBOARD TAIL PADS

PERFORMANCE TRACTION

Designed for high performance surfing, these tail pads will have you shredding in no time.

**X**

Quality you can trust.  
Surf with confidence

JUNIPER HARPER



## COR\_X SHORTBOARD TAILPAD

TP76

Length: 305mm  
Width: 300mm  
Arch: 7mm  
Kick: 25mm



3 PIECE  
TRACTION



DIAMOND  
GROOVE



POWER KICK



BASE-FLEX



BEIGE

## COR\_X FISH TAIL PAD

TP77

Length: 305mm  
Width: 315mm  
Arch: 7mm  
Kick: 25mm  
Features: Base-Flex



3 PIECE  
TRACTION



DIAMOND  
GROOVE



POWER KICK



BASE-FLEX



BEIGE



BLUE



MIDNIGHT



SAGE



BLUE



BRICK



BRICK



WASHED BLACK



BLACK



WASHED BLACK



BLACK



CORAL / BLACK



OLIVE / BLACK

**BLAZED**

TP58

Length: 305mm  
 Width: 300mm  
 Arch: 7mm  
 Kick: 25mm



BLACK



X2 BOOMERANG PIECES  
 Low profile brushed EVA.

X5 PIECE DESIGN  
 Extends the traction area on your board.

**GODFATHER**

TP19

Length: 364mm  
 Width: 300mm  
 Arch: 7mm  
 Kick: 25mm



BLACK / AQUA



BLACK / LIME

**GROOMMET**  
**MICRO**

TP66

Length: 290mm  
 Width: 280mm  
 Arch: 7mm  
 Kick: 25mm



BLACK

**FISH**

DESIGNED FOR SWALLOW TAILS

TP67

Length: 330mm  
 Width: 320mm  
 Arch: 5mm  
 Kick: 17mm  
 Features: Base-Flex

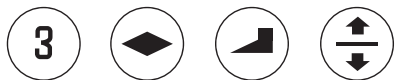

3 PIECE TRACTION   DIAMOND GROOVE   POWER VERT TAIL INSERT   BASE-FLEX



5 PIECE TRACTION   SQUARE GROOVE   POWER KICK   2X BOOMERANG



3 PIECE TRACTION   DIAMOND GROOVE   POWER KICK   BASE-FLEX

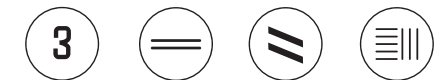

3 PIECE TRACTION   SUPER THIN LIGHTWEIGHT   SLOTTED GROOVES   MULTI-DIRECTIONAL CORDUROY

CENTRE DECK TRACTION

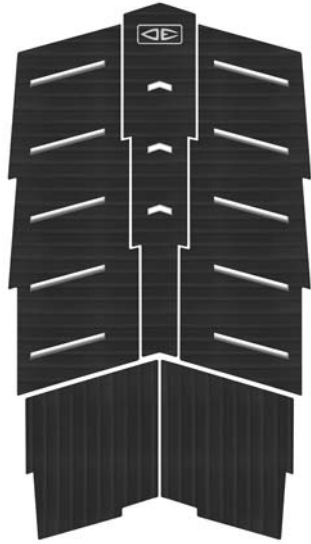

BLACK

**DAKODA WALTERS CENTRE DECK**

PRO SERIES

TP65

LENGTH: 705mm  
WIDTH: 380mm

- 5 PIECE TRACTION
- SUPER THIN LIGHTWEIGHT
- SLOTTED GROOVES
- MULTI-DIRECTIONAL CORDUROY

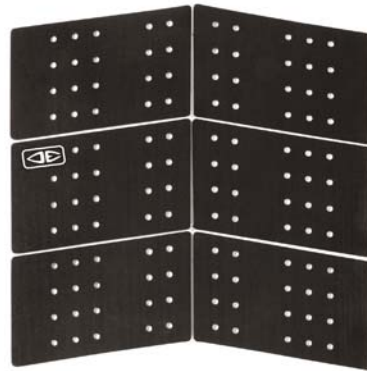

BLACK

**MONKEY MAGIC**

TP36

LENGTH: 370mm (unspread)  
WIDTH: 370mm (unspread)

- 6 PIECE TRACTION
- FLAT BRUSHED
- PERFORATION
- SUPER THIN LIGHTWEIGHT



BLACK

**DOWN THE LINE**

TP50

LENGTH: 495mm  
WIDTH: 375mm (unspread)

- 3 PIECE TRACTION
- FLAT BRUSHED
- PERFORATION
- SUPER THIN LIGHTWEIGHT



BLACK

**BOOMERANG**

TP39

LENGTH: 79mm (1 piece)  
WIDTH: 149mm (1 piece)

- 4 PIECE TRACTION
- FLAT BRUSHED
- PERFORATION
- SUPER THIN LIGHTWEIGHT

**TRAVEL RAX  
& TIE DOWNS**





#### RUBBER COVERED CAM BUCKLES

Strong, secure, rust-proof buckles with rubber casing for scratch prevention.



#### PVC TOP LAYER

Easy to wipe clean excess wax or grime left on top of pads.



#### WEBBING

High strength. UV treated and tested. Tight weave for strength and soft hand feel to help prevent scratching.



#### FITS MOST CARS

Simple attachment through doors to fit most vehicle makes.



#### RAISED EVA FOAM PADS

Extra high EVA foam pads. Keeps handles and zips of board-covers clear of car roof. The padded base has a soft fabric to prevent scratching.



## QUICK RAX

SARX15

LOAD: 1-3 SHORTBOARDS, 1 LONGBOARD OR 1 SUP

- Protective Rubber Cam Buckle
- Soft, flexible & secure
- Easy to attach & remove
- Suits cars without roof gutters



## RAP RAX

SARX01

LOAD: 1-4 SHORTBOARDS, 2 LONGBOARDS OR SIMILAR LOADS

- Protective Rubber Cam Buckle
- Aerodynamic pads
- Soft, flexible and secure
- Easy to attach & remove
- Suits cars without roof gutters



## MULTI PURPOSE RAX

SARX17

FOR SURFBOARDS / SUP / LONGBOARDS

LOAD: 4 SURFBOARDS, 2 SUPS OR 2 LONGBOARDS OR COMBO OF SIMILAR LOAD WEIGHT

- Protective Rubber Cam Buckle
- Webbing anchor straps designed to suit varying load widths
- Extra wide, heavy duty 38mm webbing
- Aerodynamic pads
- Soft, flexible and secure
- Easy to attach & remove
- Suits cars without roof gutters



## TIE DOWN STRAPS

8'0" / 2.5M SARX05  
12'0" / 3.6M SARX06  
16'0" / 4.8M SARX10

SURFBOARD CARRYING STRAPS

- Durable, 25mm width webbing
- Protective Rubber Cam Buckle
- Velcro loop to secure excess webbing strap
- Easy to attach & remove
- Storage Bag



## SUP/LONGBOARD TIE DOWN STRAPS

10'0" / 3.0M SARX44  
14'0" / 4.2M SARX19

EXTRA WIDE SUP / LONGBOARD CARRYING STRAPS

- Extra wide, heavy duty 38mm webbing
- Protective Rubber Cam Buckle
- Velcro loop to secure excess webbing strap
- Easy to attach and remove
- Designed for cars with roof racks
- Storage Bag



REUSABLE STORAGE BAG

Durable, zip-close bag. Handy for storage or transportation.

## RAX PADS - SMALL

SARX08

SURFBOARDS, LONGBOARDS, SUPS OR SIMILAR LOADS

- Length : 500mm (20") Width : 100mm (4")
- Added protection for surfboards
- Aerodynamic EVA moulded pads
- Padding for flat bar type racks only. Couple with O&E Tie Downs to vehicle roof racks.
- Attach with adjustable velcro securing system.



## RAX PADS - LARGE

SARX50

SURFBOARDS, LONGBOARDS, SUPS OR SIMILAR LOADS

- Length : 900mm (36") Width : 100mm (4")
- Added protection for surfboards
- Aerodynamic EVA moulded pads
- Padding for flat bar type racks only. Couple with O&E Tie Downs to vehicle roof racks.
- Attach with adjustable velcro securing system.



## RAX PADS - ROLL BAR

SARX47

SURFBOARDS, LONGBOARDS, SUPS OR SIMILAR LOADS

- Length : 560mm (22")
- To suit roll bars for added protection for loads
- EVA moulded U shape pad
- Secure pad to roll bar with the webbing tie down
- Couple with O&E Tie Downs to secure your load



## TAIL GATE

SARX13

1-2 SURFBOARDS, LONGBOARDS OR SUPS

- Surf Board carrying Rax for utility type vehicles
- Ultra soft fleece liner- protects your vehicle's finish
- Moulded silicone buckle covers for car protection
- Padded buckle pads for tailgate protection
- Fits all types of tailgates



## BOARD STORAGE

Keeping your entire quiver neat and tidy in-between surfs.

Made from high quality materials, designed to last. Storage products that compliment your lounge room and turn your board into a display piece.





### SINGLE VERTICAL SURFBOARD DISPLAY RACK

SARX41

FITS:1 BOARD

- Fits board WIDTH: 21.5" (55mm)
- Fits board THICKNESS: 3" thick (75mm)
- H 630mm X W 370mm X D 500mm (ASSEMBLED)
- Ideal for displaying and making your boards a show piece
- Holds one surfboard in a vertical position
- Heavy duty powder coated steel construction
- Rubber protection tubing for fins and rails



### WALL/VAN SURFBOARD RACK

SARX27

FITS: 1 SURFBOARD

- Board racks for mounting to wall studs / van walls
- H 470mm X D 150mm
- Strong aluminium construction
- Foam padding protects your board



### FREE STANDING RACK

SARX29

FITS:1-4 BOARDS

- H 1220mm X W 740mm X D 600mm (ASSEMBLED)
- Rust free aluminium frame
- 50mm padded EVA foam protective sleeves
- Ideal for apartment or garage
- No fixing to walls required / no need to punch holes in walls keeps landlords & the Mrs happy



### SHORTBOARD TIMBER WALL DISPLAY RACK

SARX45

FITS: 1 SURFBOARD

- Board racks for mounting to wall
- H 335mm X D 190mm X W 35mm
- Turns your board into a display piece
- Foam padding protects your board
- Suits all board lengths to weights of 10kg



### LONGBOARD TIMBER WALL DISPLAY RACK

SARX48

FITS: 1 BOARD

- Board racks for mounting to wall
- H 320mm X W 360mm X D 35mm
- Turns your board into a display piece
- Foam padding protects your board
- Suits all board lengths to weights of 10kg

## BOARD STORAGE



### TIMBER FREE STANDING RACK

SARX40

FITS: 1-4 BOARDS

- H 1470mm X W 680mm X D 640mm (ASSEMBLED)
- Turns your board quiver into a display piece
- Curved timber ribs with clear finish
- 50mm padded EVA foam protection sleeves for tails and rails of boards
- No fixing to walls required



### INVISIBLE WALL DISPLAY RACK - HORIZONTAL

SARX52

FITS: 1 SURFBOARD

- Display your prized possession and make your board a show piece
- H 335mm X D 190mm X W 35mm
- Focus is all on your boards as racks are almost invisible
- Horizontal or angled display rack using quality polished invisible acrylic
- Board rails are supported by cushioned bumpers
- Suits all board lengths to weights of 10kg



### INVISIBLE WALL DISPLAY RACK - VERTICAL

SARX51

FITS: 1 SURFBOARD

- Display your prized possession and make your board a show piece
- Focus is all on your boards as racks are almost invisible
- Vertical display rack up using quality polished invisible acrylic
- Adjustable rail arms on centre bracket to suit boards 17.5" to 23.5" wide
- Suits all board lengths to weights of 10kg
- Choice of 2 tail attachments included; suits all board types with or without fins



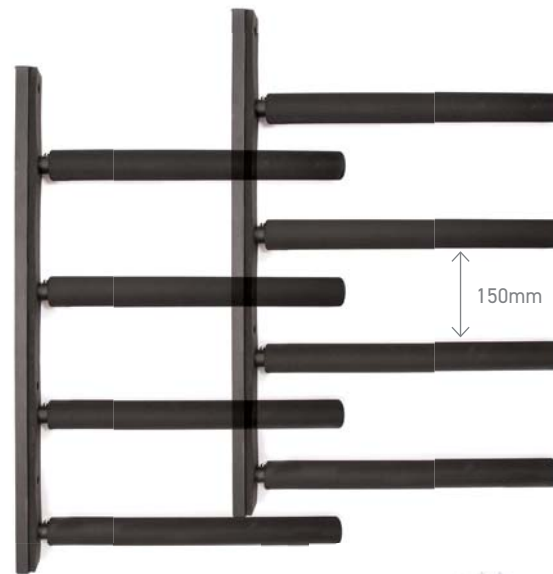

### SURFBOARD STACK RACK PAIR

SARX11

1-4 BOARDS (WITH FIN) HORIZONTAL STACKING OR UP TO 8 BOARDS WITHOUT FIN

- 1-8 boards vertical stacking (with fins) or up to 16 boards without fins
- W 780mm X D 500mm (ASSEMBLED) X2
- Heavy duty metal frame
- 50mm protective EVA padded sleeves
- Includes hardware for attaching to wall



### SURFBOARD STACK RACK SINGLE

SARX38

1-4 BOARDS (WITH FIN) VERTICAL STACKING OR UP TO 8 BOARDS WITHOUT FIN

- W 780mm X D 500mm (ASSEMBLED)
- Heavy duty metal frame
- 50mm protective EVA padded sleeves
- Includes hardware for attaching to wall

## BOARD STORAGE

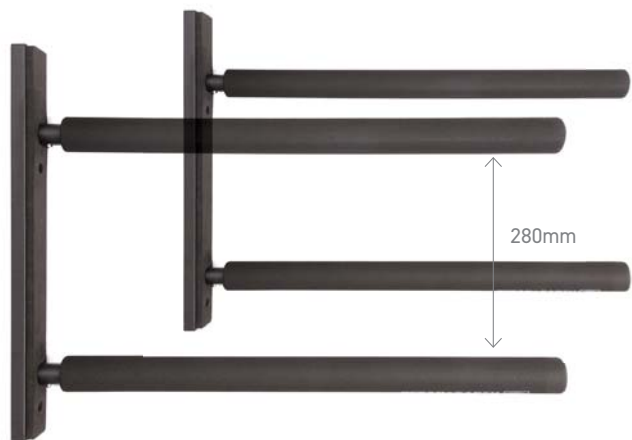

### SUP/ LONGBOARD STACK RACK PAIR

SARX32

FITS 1-2 BOARDS WITH FINNS OR 4 BOARDS WITHOUT FINNS

- D 700mm X H 470mm (ASSEMBLED) X2
- Heavy duty metal frame
- Holds boards up to 34" wide
- 60mm protective EVA padded sleeves
- Includes hardware for attaching to wall



### SUP / LONGBOARD WALL RACK

SARX33

FITS 1 BOARD

- H 450mm X W 280mm
- Wall storage for 1 board
- Heavy duty metal frame
- 50mm protective EVA padded sleeves
- Detachable arms for when not in use
- Suits all board lengths up to 15kgs



### EVA PADDED FLOOR MAT

SARX37

1-4 BOARDS (WITH FINNS) VERTICAL STACKING OR UP TO 8 BOARDS WITHOUT FINNS

- W 760mm X D 460mm X H 20mm
- Protects surfboard tails, cushioning them from the ground, preventing damage
- High quality 20mm thick EVA. Grooved surface stops boards slipping
- Use with Ocean & Earth stack rax (sold separately) to store your surfboards

## BIKE RACKS





## SIDE LOADER BIKE RACK

SARX24

FITS: 1 BOARD

- Fits most bikes, including mountain bikes
- Attaches easily under seat post (25mm to 32mm Ø)
- Anodised, rust resistant aluminium frame
- Adjustable EVA padded arms - fits most board sizes up to 8'
- A safe way to ride to the beach - board secure by your side
- Strong, durable construction - doesn't damage your bike
- Tie downs to secure surfboard



## REAR MOUNT BIKE RACK

SARX07

FITS: 1 BOARD

- Fits most bikes
- Attaches easily to seat post
- Strong aluminium frame
- EVA Padded arms - protects surfboard
- A safe way to ride to the beach
- Strong, durable construction - won't damage your bike
- Elastic straps to secure surfboard



## MOPED RACK

SARX49

FITS: 1 BOARD

- Universal fit for most E-bikes, scooters, mopeds or motorbikes with rear luggage racks
- Anodised, rust resistant aluminium frame
- Adjustable EVA padded arms - fits most board sizes up to 8'
- Soft padded EVA foam to protect your board
- Tie Downs to secure your board
- Easy 1 off installation with included Allen key
- Constructed in sections so it can be taken apart for quick and easy storage



## HOIST CEILING RACK

SARX30

FITS: 1-2 SUP / LONGBOARDS OR 4 SURFBOARDS

- Heavy duty pulley system
- Adjustable height
- Holds up to 40kgs
- Easy installation for garage ceilings

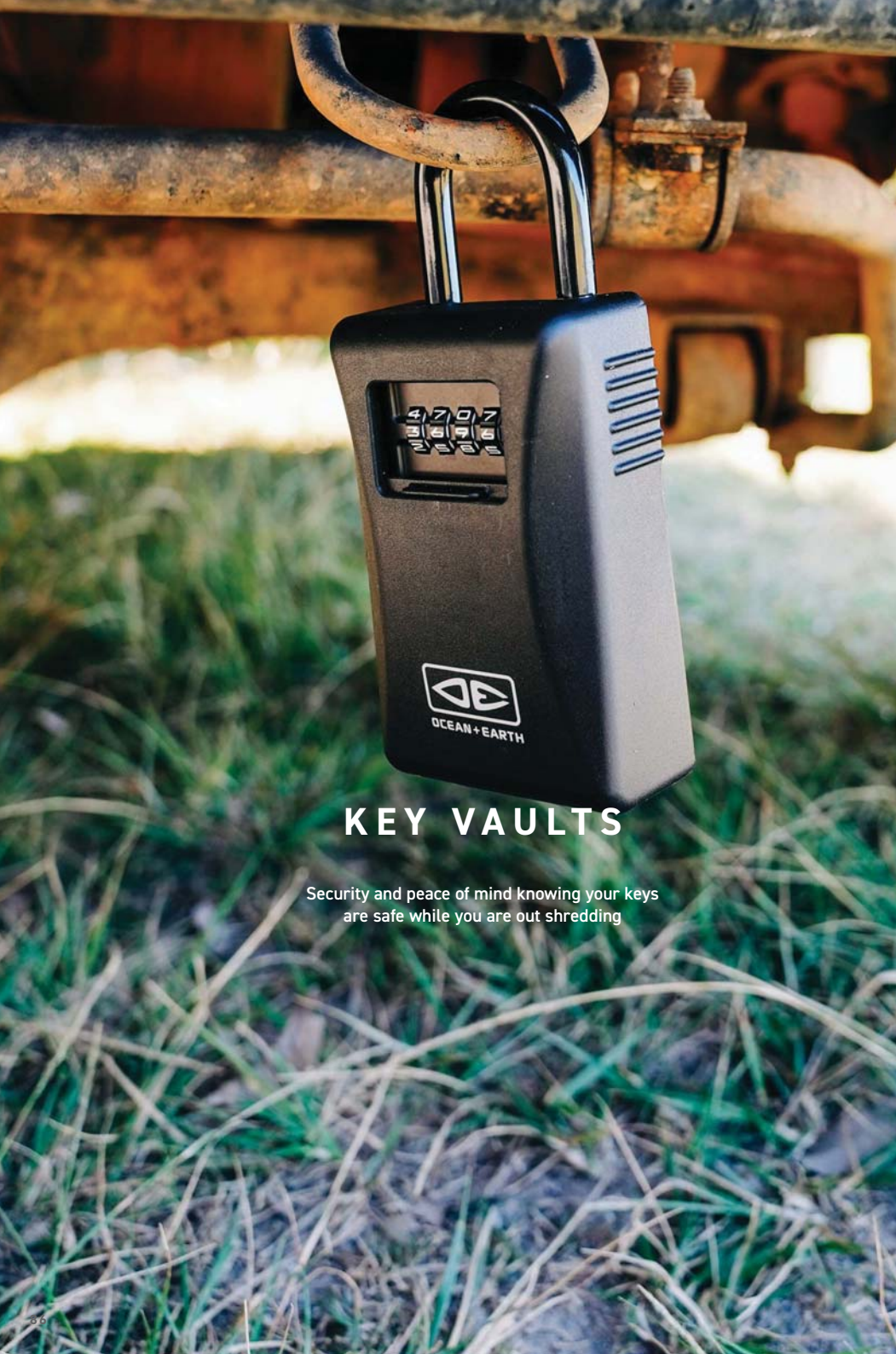

## KEY VAULTS

Security and peace of mind knowing your keys are safe while you are out shredding



### COMPACT KEY VAULT

SARX43

SAFE KEY STORAGE WHILE SURFING

INTERNAL KEY COMPARTMENT SIZE:  
67mm WIDE x 26mm HIGH x 22mm DEEP

- Dial code combination locking
- Compact size
- Heavy duty toughened steel metal case
- Weatherproof



### KEY VAULT

SARX28

SAFE KEY STORAGE WHILE SURFING

INTERNAL KEY COMPARTMENT SIZE:  
69mm WIDE x 74mm HIGH x 22mm DEEP

- Dial code combination locking
- Large key storage area - fits most key types
- Heavy duty toughened steel metal case
- Weatherproof Cover

\* Recommended with Signal Blocking Pouch

## KEY VAULTS



### HEAVY DUTY KEY BANK

SARX36

SAFE KEY STORAGE WHILE SURFING

INTERNAL KEY COMPARTMENT SIZE:  
54mm WIDE x 100mm HIGH x 26mm DEEP

- Push button combination locking system
- Large key storage area - fits most key types
- Heavy duty toughened steel metal case with weatherproof protective outer rubber covering

\* Recommended with Signal Blocking Pouch



### SIGNAL BLOCKING KEY POUCH

SARX53

- For close proximity car keys
- Constructed using technical materials that block signals from close proximity car keys
- Designed for use inside key vaults

1. Lock your car
2. Place proximity car key inside pouch
3. Seal pouch, then place inside key vault
4. Lock key vault



### TRAVEL LOCK

SARX46

Keep your equipment safe and secure with our compact surf travel lock. This lock was designed to be transported by the U.S. Transportation Security Administration (TSA) and allows the TSA to be able to unlock your bag using special access codes and tools if the need arises for a baggage search. This lock can then be relocked by the TSA with no damage to the lock on your travel bag / board cover.

- Use with Ocean & Earth travel cover's lockable zipper heads

# RESIN & REPAIR KITS

We have you covered no matter what repair job you need to do, whether you are travelling or at home.



## POLY 1oz

SOLARCURE RESIN  
SARE05

- Includes 28g (1oz) tube of fibreglass impregnated epoxy resin
- Sandpaper and applicator



## POLY 2oz

SOLARCURE REPAIR KIT  
SARE06

- Includes 55g (2oz) tube of fibreglass impregnated resin
- Fibreglass cloth
- Sandpaper and applicator



## EPOXY 1oz

SOLARCURE RESIN  
SARE07

- Includes 28g (1oz) tube of fibreglass impregnated epoxy resin
- Sandpaper and applicator



## EPOXY 2oz

SOLARCURE REPAIR KIT  
SARE13

- Includes 55g (2oz) tube of fibreglass impregnated resin
- Fibreglass cloth
- Sandpaper and applicator



## SOFT BOARD REPAIR 1oz

SOFTBOARD REPAIR  
SARE17

- Includes 28g (1oz) tube of clear finish, water resistant soft board repair silicone and applicator
- Bonds to soft board surfaces and styrofoam cores.

RESIN & REPAIR KITS



FIBREGLOSS REPAIR KIT

SARE01

- 250ml resin
- 7.5ml catalyst
- 6oz cloth
- Chop mat Q Cell filler
- Foam mixing cup and sticks
- 2 grades of sand paper and instructions



POLYESTER RESIN

SARE02

250ML



MEKP CATALYST

SARE04

15ML



WATERPROOF DING TAPE

(5 PIECES 75MM X 50MM)  
SARE15

(3 PIECES 115MM X 90MM)  
SARE16

- Quick fix - Gets you back in the water in minutes
- Essential surfer's travel accessory



PRO-TIP

SURFBOARD NOSE PROTECTION  
SARE08

- Includes two different sized Pro Tips
- Super Glue
- Sandpaper & applicator



WETSUIT REPAIR KIT

SARE11

- 15ml tube of Neoprene Repair Cement
- Cement applicator brush
- One 120mm x 70mm Iron-On Neo Patch
- Heat Shielding Paper
- Instructions Sheet

**NEOPRENE REPAIR CEMENT:**  
Industrial strength neoprene cement repairs tears & damaged seams.

**IRON-ON NEOPRENE PATCH:**  
Strong, flexible fabric repairs larger holes, gouges & worn areas.

# FINS

Performance fins for every board and wave.  
This series will have your board dialled in for all conditions and performance levels



**COMMITTED TO  
PLASTIC REDUCTION**

This product range comes with plastic free packaging.  
Another step in the right direction to help eliminate single use plastic.



## OE1 - WHIP THRUSTER

Whippy turns in the pocket and sliding the tail for lighter more agile surfers.

CONSTRUCTION: HONEYCOMB

### SINGLE TAB

BH23S	SMALL	BLACK
BH23S	MEDIUM	BLACK
BH23S	LARGE	BLACK

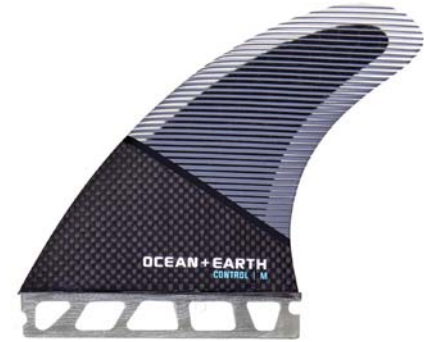

## OE2 - CONTROL THRUSTER

An all round consistent / predictable feel suited to all types of conditions and skill levels.

CONSTRUCTION: CARBON / GLASS

### SINGLE TAB

BH24S	SMALL	BLACK
BH24S	MEDIUM	BLACK
BH24S	LARGE	BLACK



## OE3 - SPEED THRUSTER

Speed generating, critical turns and high performance surfing. Ideal for power surfing and big airs.

CONSTRUCTION: MULTI-DIRECTIONAL CARBON / GLASS

### SINGLE TAB

BH25S	SMALL	BLACK
BH25S	MEDIUM	BLACK
BH25S	LARGE	BLACK



## Q2 - CONTROL QUAD 2 REAR FINS

Drive / speed / loose with moderate control can be used with any series.

CONSTRUCTION: CARBON / GLASS

### SINGLE TAB

BH26QS	ONE SIZE	BLACK
--------	----------	-------



**POLYCARBONATE THRUSTER**

A balanced all-round fin  
CONSTRUCTION: POLYCARBONATE

**SINGLE TAB**

BH30S  
BH30S  
BH30S



SMALL  
MEDIUM  
LARGE

**DUAL TAB**

BH30D  
BH30D  
BH30D



SMALL  
MEDIUM  
LARGE



**OE1 - WHIP TWIN FIN 5.5"**

Designed for speed. With enough flex to whip through turns.  
CONSTRUCTION: HONEYCOMB

**SINGLE TAB**

BH33S ONE SIZE WHITE



**HONEYCOMB SINGLE FIN**

Tried and tested fin template with the perfect combination of pivot and rake.  
This is the go-to fin for the O&E Happy Hour boards.

CONSTRUCTION: HONEYCOMB

**STANDARD SINGLE TAB** with SCREW & PLATE

BH31	7"	WHITE
BH31	8"	WHITE
BH31	9"	WHITE



**SCREW & PLATE**

PACK 20 (1 PER PACK)

SASS07



**CREATIVE ARMY SINGLE FIN**

The Creative Army Single Fin has been meticulously designed and refined by former world longboard champ Josh Constable. This is the go-to fin for the Creative Army Series.

CONSTRUCTION: HONEYCOMB

**STANDARD SINGLE TAB** with SCREW & PLATE

BH35	8"	CHARCOAL
BH35	9"	CHARCOAL



FUTURES /  
SOFTBOARDS



FCS 1 /  
FCS 2

**FIN SCREW X2**

PACK 20 (2 SCREWS PER PACK)

BH40 SMALL  
BH23 LARGE

# BODYBOARD ACCESSORIES



## BICEP MOULDED COIL

SBBA04

WAVE SIZE: Up to 6ft  
LENGTH: 4' / 1.2m  
CORD Ø: 7mm Coiled  
HORN TYPE: Moulded Diamond-Flex  
SWIVEL: Single  
STRAP: 38mm Padded + Crank-strap

BLACK BLUE



**BASIC WRIST COIL**

SBBA03

WAVE SIZE: Up to 4ft  
 LENGTH: 4' / 1.2m  
 CORD Ø: 7mm Coiled  
 HORN TYPE: Moulded Basic  
 SWIVEL: None  
 STRAP: 28mm Padded

■ BLACK ■ BLUE ■ PINK ■ LIME



**BASIC STRAIGHT CORD**

SBBA01

WAVE SIZE: Up to 3ft  
 LENGTH: 3' / 1.0m  
 CORD Ø: 6mm Straight  
 HORN TYPE: Moulded Basic  
 SWIVEL: None  
 STRAP: 28mm Padded

■ BLACK ■ BLUE



**FLAT TOP PLUG 10 PACK**

SBBA31



**FLATROCK BB COVER**  
SCBB01

FITS:	1 bodyboard + gear
-------	--------------------

- Padded back straps
- Large pocket - fits fins and gear
- Drainage mesh



**STRETCH BB COVER**  
SCBB04

FITS:	1 bodyboard
-------	-------------

- Drawstring closure
- Thick Polyester stretch fabric
- Great sun protection for your booger



**RAZOR FINS**  
SBBA42

SIZES:	XS, S, M, L, XL
--------	-----------------

- High quality rubber compound
- Contoured heel strap scoop
- Soft foot pocket
- V-shaped rail edge for power & thrust
- Balanced thrust - symmetrical blade design



### DELUXE FIN SAVERS

SBBA29

Padded ankle straps  
Curved, secure closure clasp  
Easy to attach & remove



### FLIPPER SAVERS

SBBA30

Padded ankle straps  
Double secure closure  
Easy to attach & remove



### 1MM NEOPRENE BOOTY

SBBO02

SIZES:	XS, S, M, L, XL, 2XL
--------	----------------------

High quality neoprene construction  
Non-slip tread on bottom panel



### NEOPRENE SUMMER SOX

SBBO03

SIZES:	XXS, XS, S, M, L, XL, 2XL
--------	---------------------------

High quality neoprene construction  
Non-slip tread on bottom panel



**MAX WAX 75G**

SOLD IN A BOX OF 48

- New, extra tacky formula
- Superior traction for upside-down surfing!
- Recyclable packaging!

**TROPICAL / BASE**

SAWX01

Extra hard formula for water temps 23°C (75°F) & above



**WARM**

SAWX02

Hard formula for water temps 19 - 23°C (65 - 75°F)



**COOL**

SAWX03

Soft formula for water temps 14 - 19°C (55 - 65°F)



**COLD**

SAWX04

Extra Soft formula for water temps up to 15°C (60°F)



WATER TEMP



WAX ACCESSORIES



**BENDER WAX COMB**

SAWX62

30 PACK

- Flexible design and curved outline for easy scraping of surfboard rails.
- Red, blue, yellow colours



**WAX REMOVER**

SAWX15

235ML / 8OZ

- Removes wax from boards perfectly before re-applying a new coat



**WAX FRIDGE**

SAWX16

FITS WAX / FINS / FIN KEYS / SUNSCREEN

- Silver reflective outer fabric
- Repels the sun and heat
- EVA foam walls keeps interior cool
- Suitable for surf accessories & action sport cameras
- Elastic fin key loop



**LEGGIE STRING COMBO**

SLMC03

40 PACK

- Each unit includes:
- Wax comb
  - Fin key
  - Leggie string with plug buddy



**LEGGIE STRING**

SLMC02

50 PACK

Each unit includes leggie string with plug buddy

Plug buddy ensures leash string can be easily threaded through surfboard plug.



**PADDLE COIL CORD**

SASS04

SUITABLE FOR ALL PADDLE SPORTS

- 7mm coiled urethane
- Diamond Flex moulded ends
- Double swivel

A high-angle, wide shot of a surfer riding a massive, curling wave. The wave is a deep, dark teal color, with a thick, white, foamy crest that is curling over. The surfer is positioned in the lower right quadrant of the frame, riding the base of the wave's face. The surfer is wearing a black wetsuit and is leaning forward, with their arms extended for balance. The surfboard is visible, with a red and black design. The overall scene is dynamic and powerful, capturing the raw energy of the ocean.

## TOW SERIES

Serious equipment for serious situations. Built with the strongest materials and best workmanship available, then tested in the most extreme conditions.

MAX MCGUIGAN

T O W   S E R I E S



PRO FLOATING TOW ROPE

TSTR02

- Size: 10 metres in length
- Heavy duty nylon construction
- Super thick foam insert for flotation & visibility
- Heavy duty quick release clip
- Stiffened clearance section from base of ski



TOW ROPE HANDLE

TSHA01

- Heavy duty nylon construction
- Deluxe EVA padded handle
- Attach to any rope easily & securely



316 STAINLESS QUICK RELEASE SHACKLE

TSHD02



316 STAINLESS 8MM BOW SHACKLE

TSHD01

## SOFT BOARDS

O&E softboards have fuller, versatile template shapes that suit entry level surfing, right through to small wave shredding. Constructed from durable, high quality materials.





NEW



RAZOR



Learn to surf micro groms. Beginner to intermediate grommets.  
Foam out no matter how good the waves are.

NEW

EZI  
RIDER

Learn to surf - first board in your quiver from groms to adults.  
Intermediate to advanced. Even if the waves are bad never miss a  
single session. Built for fun!



Happy  
HOUR  
XPS

EPOXY / SOFT

Stiff, epoxy construction suited to the surfer wanting more  
performance, but without losing the fun of a soft board.  
Looks like a soft board, rides like a real board.



The Slug gives young grommets an easy, confidence-boosting start in the waves. Its surfboard-inspired shape feels natural under the arms, helping groms glide through the water and towards their first real rides.

Built-in handles make it simple to grip and stay steady, so kids can focus on the fun of catching waves rather than worrying about holding on. And because it's nice and narrow, paddling and diving under waves becomes smoother and more manageable—helping them build skills and enjoy every moment in the surf.

**THE SLUG CONSTRUCTION**

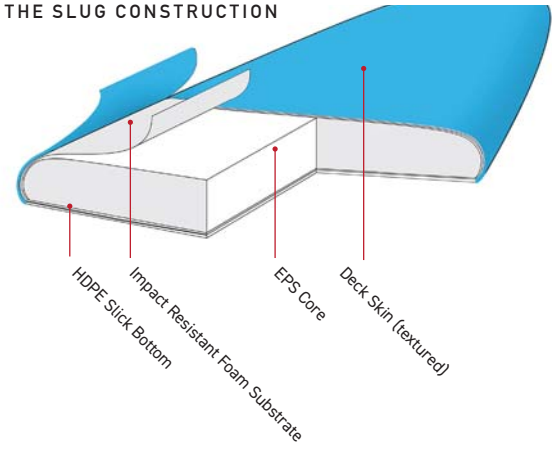

- CORE: EPS + 2 Stringers
- DECK: IXL
- BOTTOM: HDPE with mesh
- FIN BOX: Interchangeable Bolt Thru (5'2, 5'6, 6'0)

- FEATURES:
  - EPS lightweight core
  - HDPE Slick Bottom
  - Textured comfortable EVA deck

# THE SLUG



BLUE



PINK



PURPLE



SPEARMINT

**NEW**

## THE SLUG 37" HANDLES

SSS037H

DIMENSIONS: 37 3/8" X 15 3/8" X 1 1/2"  
RIDER WGT: <30kg  
Includes soft handles



BLUE



PINK



PURPLE



SPEARMINT

**NEW**

## THE SLUG 37"

SSS037

DIMENSIONS: 37 3/8" X 15 3/8" X 1 1/2"  
RIDER WGT: <30kg





# RAZOR

The grommets and beginner's bodyboard that has great shape, quality and performance.  
Fun Fun Fun!

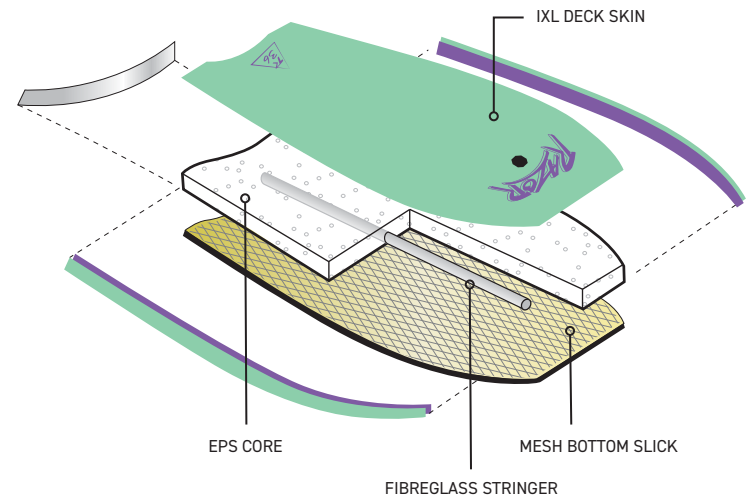

THE RAZOR

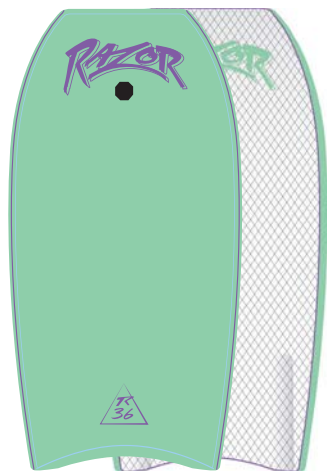

SPEARMINT

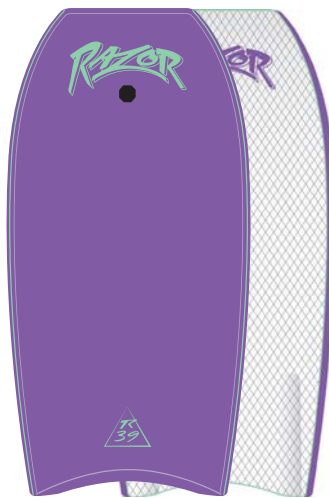

PURPLE

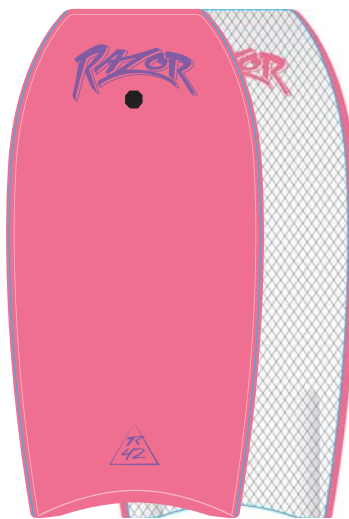

PINK



BLUE

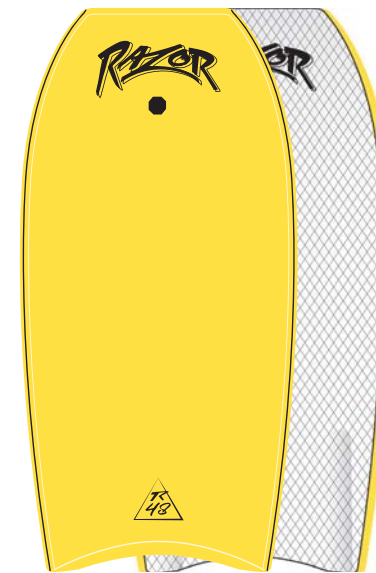

YELLOW

**NEW**

**RAZOR 2.0 36"**

ZRV236

CORE: EPS EXTRUDED  
DECK: IXL  
BOTTOM: HDPE SLICK WITH MESH  
STRINGER: x1 FIBREGLASS  
CHANNELS: GRADUATED  
LEASH PLUG: INSTALLED



**NEW**

**RAZOR 2.0 39"**

ZRV239

CORE: EPS EXTRUDED  
DECK: IXL  
BOTTOM: HDPE SLICK WITH MESH  
STRINGER: x1 FIBREGLASS  
CHANNELS: GRADUATED  
LEASH PLUG: INSTALLED



**NEW**

**RAZOR 2.0 42"**

ZRV240

CORE: EPS EXTRUDED  
DECK: IXL  
BOTTOM: HDPE SLICK WITH MESH  
STRINGER: x1 FIBREGLASS  
CHANNELS: GRADUATED  
LEASH PLUG: INSTALLED



**NEW**

**RAZOR 2.0 44"**

ZRV244

CORE: EPS EXTRUDED  
DECK: IXL  
BOTTOM: HDPE SLICK WITH MESH  
STRINGER: x1 FIBREGLASS  
CHANNELS: GRADUATED  
LEASH PLUG: INSTALLED



**NEW**

**RAZOR 2.0 48"**

ZRV248

CORE: EPS EXTRUDED  
DECK: IXL  
BOTTOM: HDPE SLICK WITH MESH  
STRINGER: x1 FIBREGLASS  
CHANNELS: GRADUATED  
LEASH PLUG: INSTALLED



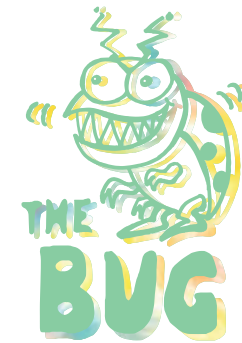

The grommets and beginner's softboard that has great shape, quality and performance.  
Fun Fun Fun!

#### THE BUG CONSTRUCTION

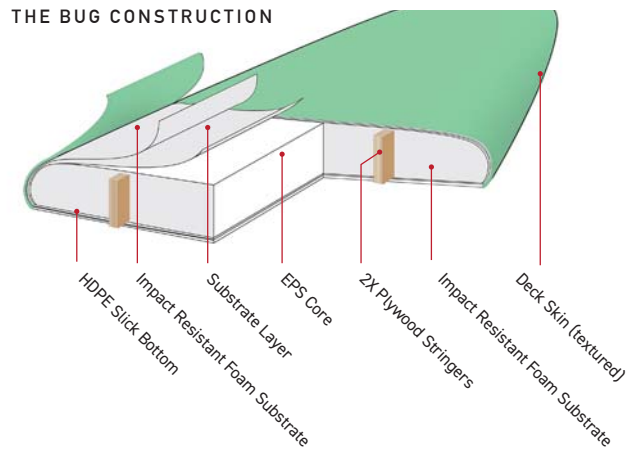

**CORE:** EPS + 2 Stringers  
**DECK:** IXL  
**BOTTOM:** HDPE with mesh  
**FIN BOX:** Interchangeable Bolt Thru (5'2, 5'6, 6'0)

**FEATURES:**

- Interchangeable Fin Box
- Compatible with most dual tab fins

THE BUG



PURPLE

**THE BUG 4'0"**

SBS040

DIMENSIONS: 4'0" x 18" x 2 1/2"  
VOLUME: 22L  
RIDER WGT: <30kg  
FIN: PU bolt through 3.5" X2

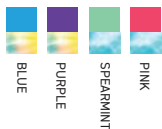

BLUE

**THE BUG 4'8"**

SBS048

DIMENSIONS: 4'8" x 19" x 2 1/2"  
VOLUME: 30L  
RIDER WGT: <40kg  
FIN: PU bolt through 3.5" X2

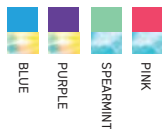

PINK

**THE BUG 5'2"**

SBS052

DIMENSIONS: 5'2" x 19 1/4" x 2 3/4"  
VOLUME: 33L  
RIDER WGT: <55kg  
FIN: PU 4.5" X3

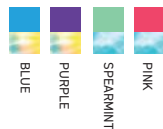

SPEARMINT

**THE BUG 5'6"**

SBS056

DIMENSIONS: 5'6" x 20 3/4" x 2 3/16"  
VOLUME: 39L  
RIDER WGT: <65kg  
FIN: PU 4.5" X3

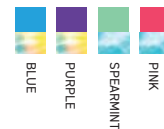

BLUE

**THE BUG 6'0"**

SBS060

DIMENSIONS: 6'0" x 21 5/8" x 3 1/8"  
VOLUME: 44L  
RIDER WGT: <75kg  
FIN: PU 4.5" X3





**PROVEN SHAPES**

Designed by professional surfboard shapers and refined over 30 years, Ezi-Rider template shapes are tested and proven to be the best.

**IXL-WBS DECK SKIN**

Crosslinked IXL PE skin with WBS (Water Barrier Skin). Highly water resistant and extremely durable. Excellent grip and impact resistant.

**EPS CORE**

EPS (Extruded Polystyrene) moulded core. Highly waterproof, lightweight and buoyant.

**HDPE BOTTOM PLATE**

1mm thick HDPE high density polyethylene plate. Durable, extra strength performance slick.

**INTERCHANGEABLE FIN BOX SYSTEM**

Compatible with most major fin brands to increase board performance. Allows quick and easy fin changing with a fin key.



# EZI RIDER

## BUILT FOR FUN

The most durable softboard on the market with the best all round shape and design.

**EZI-RIDER CONSTRUCTION**

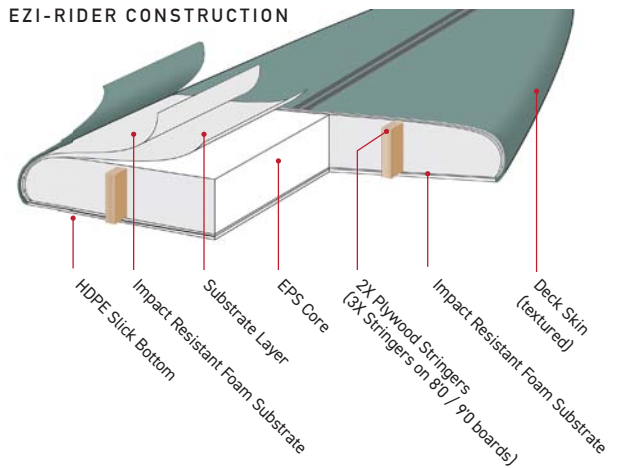

To help protect against delamination, all Ezi-Rider softboards are tested in a heat induced environment at 70°C for two hours.

- CORE:** EPS + 2 Stringers
- DECK:** IXL EBS
- BOTTOM:** 1mm HDPE
- FINS:** 3x 4.5" Soft PU
- FIN BOX:** Interchangeable Fin Box. Compatible with most dual tab fins

EZ I - R I D E R



AZURE BLUE



PINK



SAGE



WHITE



AZURE BLUE



MINT



DK BLUE

**NEW**  
EZ I-RIDER 2.0 5'6"

SES OV256

DIMENSIONS: 5'6" x 21" x 2 3/4"  
VOLUME: 40L  
RIDER WGT: <70kg



**NEW**  
EZ I-RIDER 2.0 6'0"

SES OV260

DIMENSIONS: 6'0" x 21 5/8" x 3 1/8"  
VOLUME: 47L  
RIDER WGT: <85kg

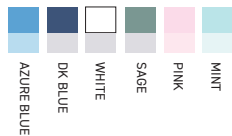

**NEW**  
EZ I-RIDER 2.0 6'6"

SES OV266

DIMENSIONS: 6'6" x 21 1/4" x 3"  
VOLUME: 52L  
RIDER WGT: <90kg

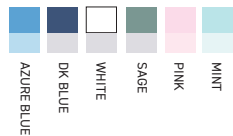

**NEW**  
EZ I-RIDER 2.0 7'0"

SES OV270

DIMENSIONS: 7'0" x 22 1/8" x 3 1/4"  
VOLUME: 60L  
RIDER WGT: <95kg

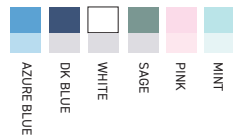

**NEW**  
EZ I-RIDER 2.0 7'6"

SES OV276

DIMENSIONS: 7'6" x 22 1/8" x 3 1/4"  
VOLUME: 64L  
RIDER WGT: <100kg

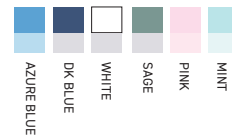

**NEW**  
EZ I-RIDER 2.0 8'0"

SES OV280

DIMENSIONS: 8'0" x 22 3/4" x 3 3/4"  
VOLUME: 80L  
RIDER WGT: <110kg

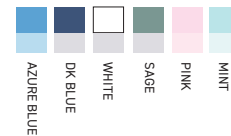

**NEW**  
EZ I-RIDER 2.0 9'0"

SES OV290

DIMENSIONS: 9'0" x 24" x 3 5/8"  
VOLUME: 93L  
RIDER WGT: <130kg

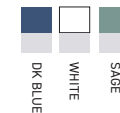

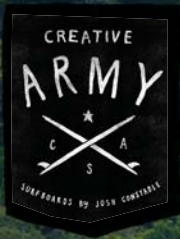

Creative Army is the love child of former WSL World Longboard Champion Josh Constable. Born and bred on the point breaks of Noosa Heads, Australia, Josh's success throughout his 20 year career speaks for itself. 1 World Title, 6 Australian Titles and some 51 career titles.

With his success, Josh has worked alongside some of the best shapers and legends in the sport including Bob McTavish, Bob Cooper, Donald Takyama, Timmy Paterson and more.

JOSH CONSTABLE

# THE GENERAL

★★★★★

## EPOXY / SOFT SERIES

It's the leader of the pack and one of the most versatile boards in the Creative Army Range. Its modern rocker makes for precise turns, fast trimming and awesome tip time.

Perhaps you are a long boarder that wants a board to nose ride, but still wants to be able to turn in those waves that aren't your perfect point setup? Or you are just learning and want to have some fun? Then this is the board for you!

### EPOXY SOFT CONSTRUCTION

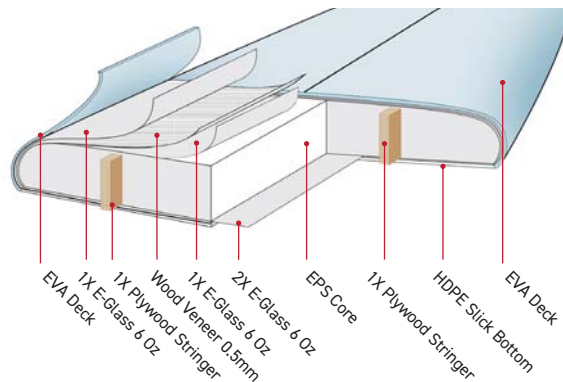

**CORE:** EPS + 2X Plywood Stringer (X1 Stringer 7'0 & 7'6)  
**DECK:** Textured EVA  
**BOTTOM:** HDPE  
**FIN BOX:** Centre - 10" Box  
 Side - Futures single tab

**FEATURES:** - Concave to Vee Bottom  
 - Modern rocker for ease of paddling, speed and turns



NEW  
 BLUE MAUVE OLIVE

## THE GENERAL EPOXY SOFT 7'0"

SBCA 70

**DIMENSIONS:** 7'0" x 22 1/2" x 2 1/2"  
**VOLUME:** 45L

**FINS:** PU 8" Single fin +  
 PU 3.75" Side fin X2

THE GENERAL EPOXY SOFT



**NEW**  
BLUE  
MAUVE  
OLIVE

THE GENERAL EPOXY SOFT 7'6"

SBCA76

DIMENSIONS: 7'6" x 22 1/2" x 2 1/2"  
VOLUME: 52L

FINS: PU 8" Single fin +  
PU 3.75" Side fin X2



**NEW**  
BLUE  
MAUVE  
OLIVE

THE GENERAL EPOXY SOFT 8'0"

SBCA80

DIMENSIONS: 8'0" x 22 3/4" x 2 3/4"  
VOLUME: 61L

FINS: PU 8" Single fin +  
PU 3.75" Side fin X2



**NEW**  
BLUE  
MAUVE  
OLIVE

THE GENERAL EPOXY SOFT 8'6"

SBCA86

DIMENSIONS: 8'6" x 23" x 3"  
VOLUME: 79L

FINS: PU 9" Single fin



**NEW**  
BLUE  
MAUVE  
OLIVE

THE GENERAL EPOXY SOFT 9'0"

SBCA90

DIMENSIONS: 9'0" x 23 1/2" x 3"  
VOLUME: 87L

FINS: PU 9" Single fin



**NEW**  
BLUE  
MAUVE  
OLIVE

THE GENERAL EPOXY SOFT 9'6"

SBCA96

DIMENSIONS: 9'6" x 23 3/4" x 3 1/8"  
VOLUME: 92L

FINS: PU 9" Single fin



Designed by She Creative Army shaper Anna Constable, specifically for female surfers. Shaped for the endless pursuit of the perfect ride.

ANNA CONSTABLE



THE KK EPOXY SOFT

EPOXY / SOFT SERIES

The KK, is a mid-length beauty that is crafted with the modern female surfer in mind, blending effortless handling with exceptional performance. Imagine gliding smoothly into waves with a board that feels like an extension of yourself. The KK's manageable length makes it easy to handle and manoeuvre, whether you're carving through small, gentle swells or charging bigger, more powerful waves. With its extra volume around your chest, it gives you that longboard glide and stability when paddling into waves that most shorter boards lack.

Its sleek design and pulled-in tail allow for fluid, stylish turns, making your movements on the water both graceful and powerful. Plus, its compact size fits comfortably in your car, so you can take your surfing spirit wherever your heart desires, whether it's a spontaneous beach trip or a weekend getaway.

This is a beautiful board to have in your quiver and ticks so many boxes! The KK board awaits, ready to take you wherever your surfing dreams lead.

EPOXY SOFT CONSTRUCTION

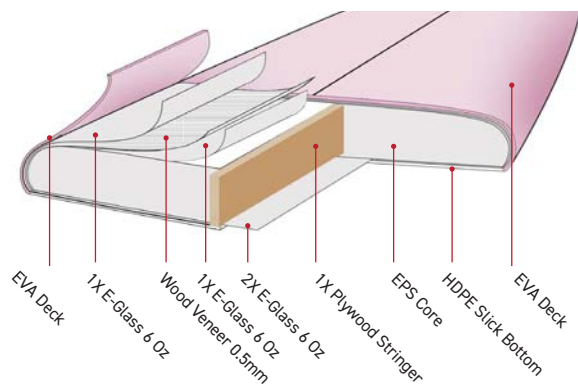

CORE: EPS + 1X Plywood Stringer  
DECK: Textured EVA  
BOTTOM: HDPE  
FIN BOX: Centre - 10" Box

FEATURES: - Concave to Vee Bottom  
- Modern rocker for ease of paddling, speed and turns



■ LILAC  
■ PINK

**KK EPOXY SOFT 6'6"**

SBCAKK66

DIMENSIONS: 6'6" x 20 3/4" x 2 5/8"

VOLUME: 42L

FINS: PU 8" Single fn

■ LILAC  
■ PINK

**KK EPOXY SOFT 7'0"**

SBCAKK70

DIMENSIONS: 7'0" x 21" x 2 3/4"

VOLUME: 47L

FINS: PU 8" Single fn

■ LILAC  
■ PINK

**KK EPOXY SOFT 7'6"**

SBCAKK76

DIMENSIONS: 7'6" x 21 1/2" x 2 3/4"

VOLUME: 51L

FINS: PU 8" Single fn

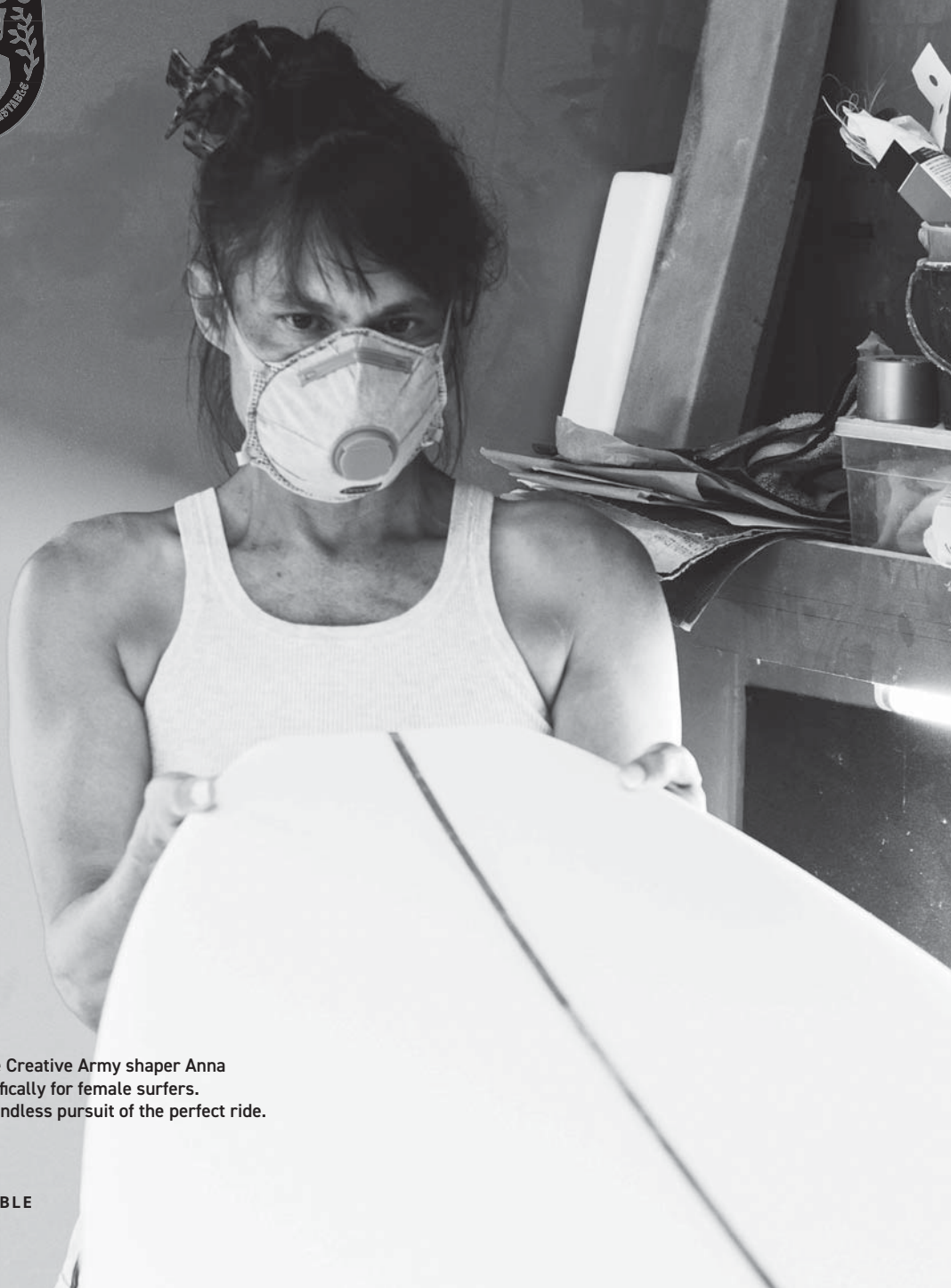
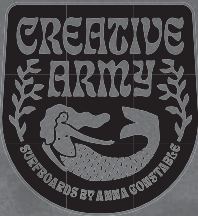

Designed by She Creative Army shaper Anna Constable, specifically for female surfers. Shaped for the endless pursuit of the perfect ride.

ANNA CONSTABLE



## EPOXY / SOFT SERIES

If versatility is what you're after, the Sar Bear will quickly become your best friend. Designed to handle everything from knee-high waves to overhead swells, this board adapts seamlessly to any conditions, keeping you both competitive and confident in the line-up.

The Sar Bear features an extended flatter mid-section, making it the best paddler among its peers and increasing your wave count significantly. Its slightly pulled-in nose prevents unwanted chop from affecting your ride, especially during late take-offs. The subtle nose concave offers exceptional stability for nose riding, letting you enjoy a smooth, controlled ride on the nose.

Its vee bottom and adjusted fin placement, makes it flow and transition smoothly from rail to rail.

Sar Bear delivers a smooth, dynamic ride session after session, ensuring you leave the water satisfied every time.

### EPOXY SOFT CONSTRUCTION

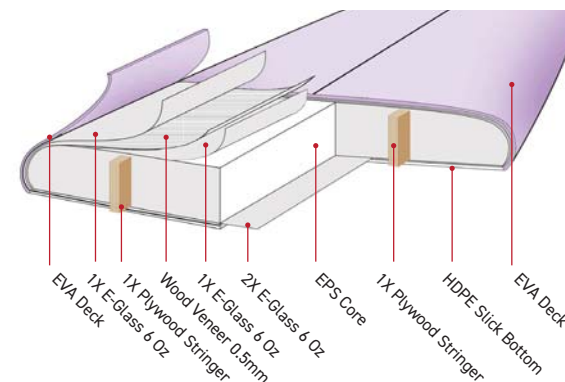

CORE: EPS + 2X Plywood Stringer  
 DECK: Textured EVA  
 BOTTOM: HDPE  
 FIN BOX: Centre - 10" Box

FEATURES: • Vee Bottom  
 • Flatter rocker for ease of paddling, speed.

THE SAR BEAR EPOXY SOFT



PINK  
LILAC

SAR BEAR EPOXY SOFT 8'0"

SBCASA80

DIMENSIONS: 8'0" x 22" x 2 1/4"

VOLUME: 52L

FINS: PU 8" Single fin



PINK  
LILAC

SAR BEAR EPOXY SOFT 8'6"

SBCASA86

DIMENSIONS: 8'6" x 22 1/4" x 2 1/4"

VOLUME: 56L

FINS: PU 9" Single fin



PINK  
LILAC

SAR BEAR EPOXY SOFT 9'0"

SBCASA90

DIMENSIONS: 9'0" x 22 1/2" x 2 5/8"

VOLUME: 63L

FINS: PU 9" Single fin



PINK  
LILAC

SAR BEAR EPOXY SOFT 9'6"

SBCASA96

DIMENSIONS: 9'6" x 22 3/4" x 2 3/4"

VOLUME: 70L

FINS: PU 9" Single fin



# Happy HOUR XPS

## EPOXY / SOFT SERIES

Constructed with lightweight EPS core and glassed in epoxy for stiffness with a soft EVA deck and soft bottom.

Designed for both fun and performance with an outline, bottom curve and evenly proportioned thickness all combining to make wave catching and manoeuvrability a breeze. A narrower tail shape and fuller nose combine to create an exceptionally versatile board added to a combination of many potential fin setups takes this board to an even higher level of performance.

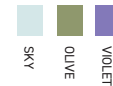

### EPOXY SOFT CONSTRUCTION

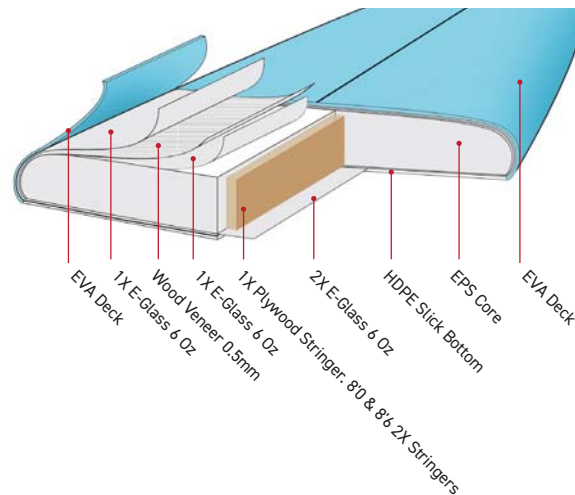

## HAPPY HOUR EPOXY-SOFT 6'0"

SBHH60

DIMENSIONS: 6'0" x 21" x 2 3/4"  
 VOLUME: 38L

SIZES: 6'0"  
 DECK: Textured EVA  
 BOTTOM: HDPE  
 FINS: X3 4.5" Polycarbonate side fins  
 FIN BOX: X5 Futures (single tab)

FEATURES: • Concave to Vee, Channel Bottom

HAPPY HOUR EPOXY SOFT

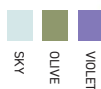

HAPPY HOUR EPOXY-SOFT 6'6"

SBHH66

**DIMENSIONS:** 6'6" x 21 5/8" x 2 7/8"  
**VOLUME:** 43L

**SIZES:** 6'6, 7'0, 7'6  
**DECK:** Textured EVA  
**BOTTOM:** HDPE  
**FINS:** 1x 8" Polycarbonate centre fin  
2x 3.75" Polycarbonate side fins  
**FIN BOX:** Centre = 10" Box  
X4 Futures (single tab)

**FEATURES:** · Concave to Vee, Channel Bottom

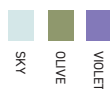

HAPPY HOUR EPOXY-SOFT 7'0"

SBHH70

**DIMENSIONS:** 7'0" x 22" x 3 1/8"  
**VOLUME:** 52L

**SIZES:** 6'6, 7'0, 7'6  
**DECK:** Textured EVA  
**BOTTOM:** HDPE  
**FINS:** 1x 8" Polycarbonate centre fin  
2x 3.75" Polycarbonate side fins  
**FIN BOX:** Centre = 10" Box  
X4 Futures (single tab)

**FEATURES:** · Concave to Vee, Channel Bottom

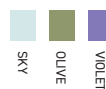

HAPPY HOUR EPOXY-SOFT 7'6"

SBHH76

**DIMENSIONS:** 7'6" x 22 1/4" x 3 1/4"  
**VOLUME:** 59L

**SIZES:** 6'6, 7'0, 7'6  
**DECK:** Textured EVA  
**BOTTOM:** HDPE  
**FINS:** 1x 8" Polycarbonate centre fin  
2x 3.75" Polycarbonate side fins  
**FIN BOX:** Centre = 10" Box  
X4 Futures (single tab)

**FEATURES:** · Concave to Vee, Channel Bottom

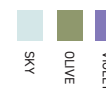

HAPPY HOUR EPOXY-SOFT 8'0"

SBHH80

**DIMENSIONS:** 8'0" x 22 1/2" x 3 1/4"  
**VOLUME:** 63.1L

**SIZES:** 8'0, 8'6  
**DECK:** Textured EVA  
**BOTTOM:** HDPE  
**FINS:** 1x 9" Polycarbonate centre fin  
2x 3.75" Polycarbonate side fins  
**FIN BOX:** Centre = 10" Box  
X2 Futures (single tab)

**FEATURES:** · Concave to Vee, Channel Bottom



HAPPY HOUR EPOXY-SOFT 8'6"

SBHH86

**DIMENSIONS:** 8'6" x 22 3/4" x 3 3/8"  
**VOLUME:** 71L

**SIZES:** 8'0, 8'6  
**DECK:** Textured EVA  
**BOTTOM:** HDPE  
**FINS:** 1x 9" Polycarbonate centre fin  
2x 3.75" Polycarbonate side fins  
**FIN BOX:** Centre = 10" Box  
X2 Futures (single tab)

**FEATURES:** · Concave to Vee, Channel Bottom



Happy  
HOUR  
PU

Full performance board with hard PU construction. The PU version adds extra responsiveness and speed, making it the highest performance board in the Happy Hour series.

Designed for both fun and performance with an outline bottom curve and evenly proportioned thickness, all combining to make wave catching and manoeuvrability a breeze. A narrower tail shape and fuller nose combine to create an exceptionally versatile board added to a combination of many potential fin setups, takes this board to an even higher level of performance.

#### PU CONSTRUCTION

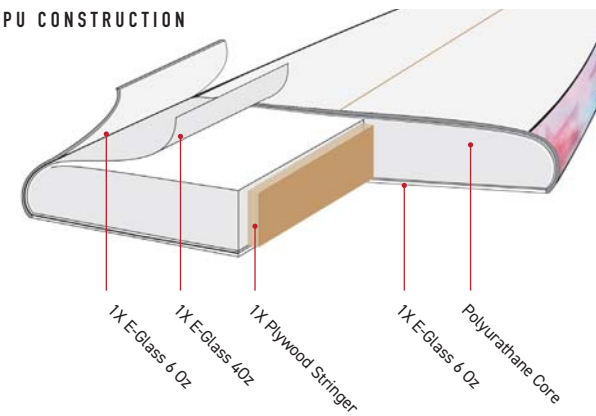

HAPPY HOUR PU



HAPPY HOUR PU 6'0"

SBHHPU60

DIMENSIONS: 6'0" x 20 3/4" x 2 1/2"  
VOLUME: 34.6L

SIZES: 6'0  
DECK: Polished  
BOTTOM: Polished Glass  
FINS: 3x 4.5" PU side fins  
FIN BOX: 5x Futures (single tab)

FEATURES: · Concave to Vee Channel Bottom  
· Minimal bottom curve  
· Narrow tail outline



HAPPY HOUR PU 6'6"

SBHHPU66

DIMENSIONS: 6'6" x 21 3/8" x 2 1/2"  
VOLUME: 37.75L

SIZES: 6'6, 7'0, 7'6  
DECK: Polished  
BOTTOM: Polished Glass  
FINS: 1x 8" PU centre fin  
2x 3.75" PU side fins  
FIN BOX: Centre = 10" Box  
4x Futures (single tab)

FEATURES: · Concave to Vee Channel Bottom  
· Minimal bottom curve  
· Narrow tail outline



HAPPY HOUR PU 7'0"

SBHHPU70

DIMENSIONS: 7'0" x 21 5/8" x 2 7/8"  
VOLUME: 47.47L



HAPPY HOUR PU 7'6"

SBHHPU76

DIMENSIONS: 7'6" x 22 1/6" x 3"  
VOLUME: 53.12L



SURF SCHOOL SOFTBOARDS

# SSB

Constructed using the highest quality materials and quality control, the SSB board range is not only designed for the best performance, but also extreme durability.

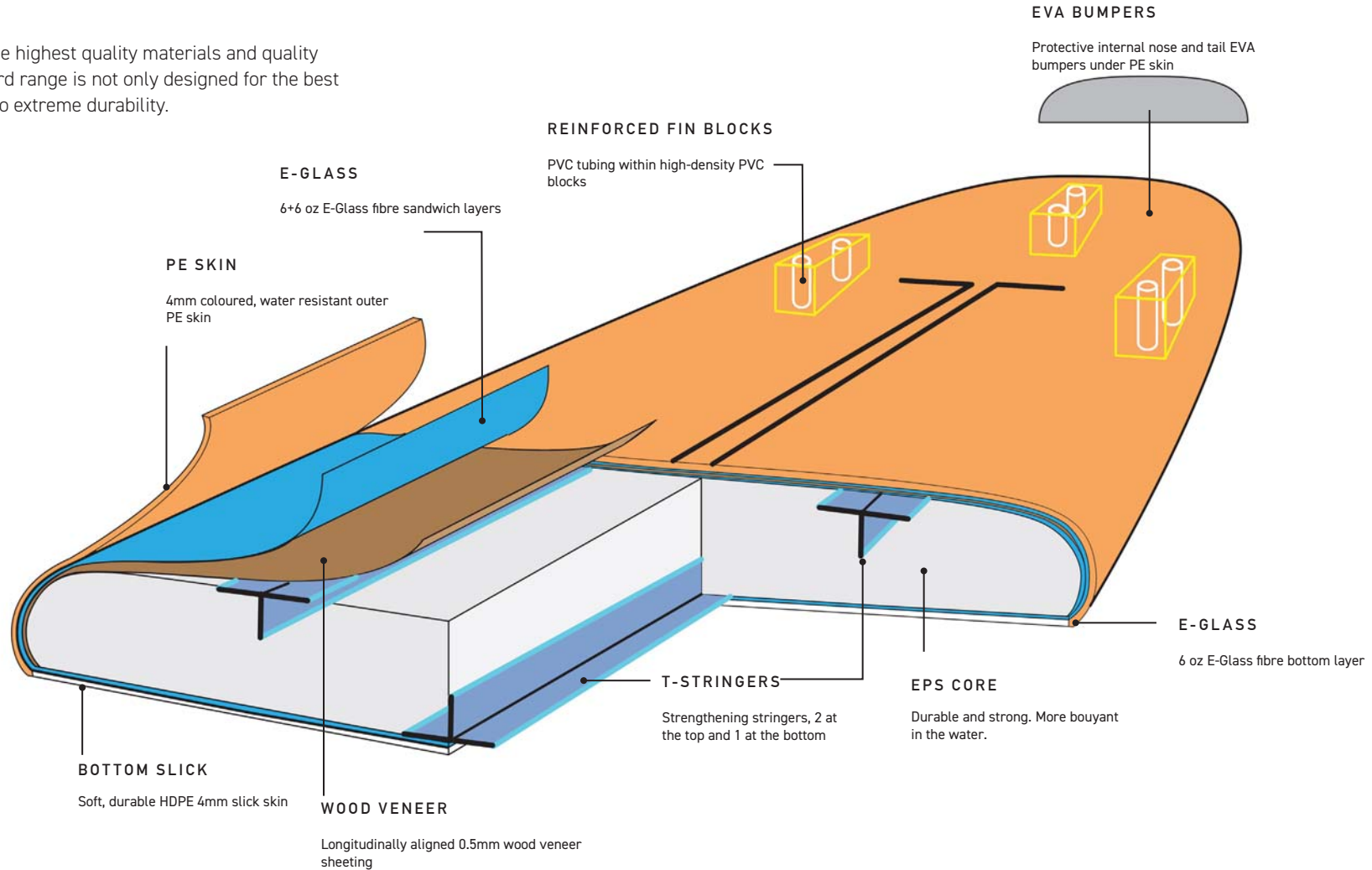

"The SSB are hands down the best learn-to-surf boards I have used. The construction is top quality and the design template makes for excellent speed and stability. Suitable for both beginner and intermediate level surfers."

Shane Wehner  
Former WCT surfer  
1999 WCT Pipeline Masters 2nd  
[www.brouleesurfschool.com.au](http://www.brouleesurfschool.com.au)

"The performance and durability of the SSB boards is unmatched. Due to the refined template design I can teach kids from beginner to intermediate with much quicker results."

Trent Munro  
2005 ASP World #5  
2005 WCT Bells Pro champion  
2001 WCT Rio Surf champion  
[www.trentmunro.com](http://www.trentmunro.com)

"Kids really enjoyed the new SSB boards and they performed much better on the waves than other boards. We tested them over a long summer season and they held up very well. So durable!"

Pam Burrridge  
1990 ASP World Champion  
[www.pamburrridge.com](http://www.pamburrridge.com)

# SSB

## REFINED TEMPLATE SHAPE

The SSB Surf School softboard range features template shapes designed by former ASP world #5 Phil 'Macca' Macdonald, specifically aimed for performance and durability, for beginner and intermediate level surfers. Just like standard surfboards, learn-to-surf boards need to be designed to maximise the surfer's ability at any level. The SSB board has been computer shaped to create a high performance learn to surf board, which allows quicker progression in surfing ability in all age groups.

### NOSE ROCKER

Increased nose rocker for less nose diving and easier paddling through waves

### TEMPLATE SHAPE

Foam distributed evenly throughout like a surfboard for better performance

### DECK GRAPHICS

Designed to aid with foot placement for beginner surfers

### EPS CORE

Lighter and more bouyant in the water for better performance

### TAIL

Wide tail area for stability

### TAIL ROCKER

Increased tail rocker for better performance manoeuvres

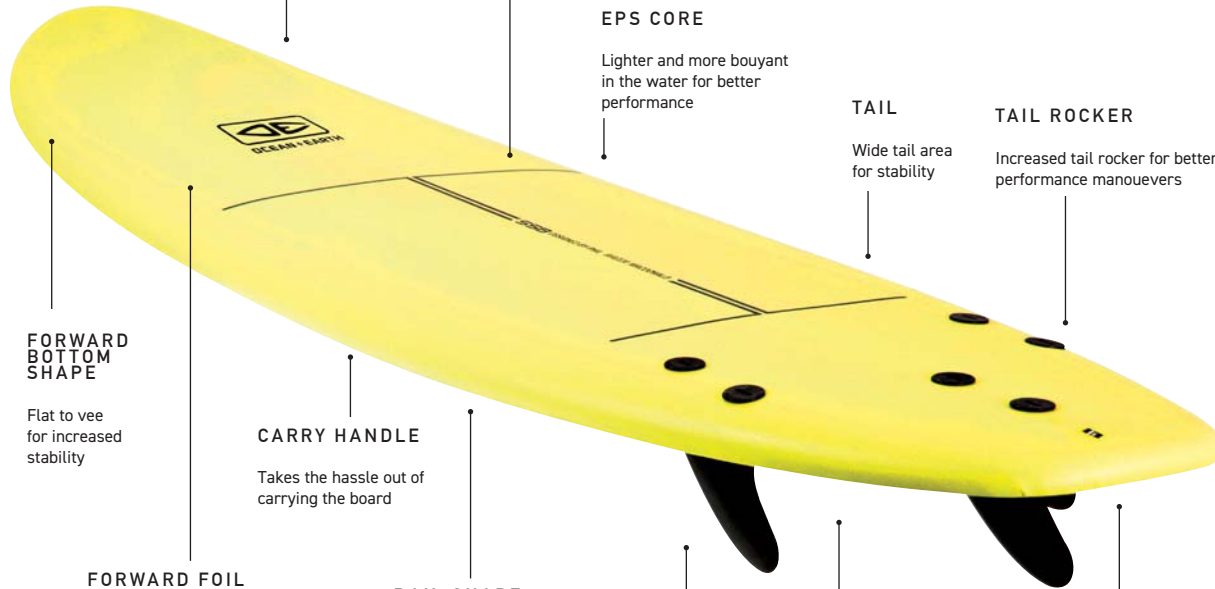

### FORWARD BOTTOM SHAPE

Flat to vee for increased stability

### CARRY HANDLE

Takes the hassle out of carrying the board

### FORWARD FOIL

Increased thickness in front section for easier paddling and stability

### RAIL SHAPE

Computer shaped rails for surfboard-like performance. Eliminates catching and assists in turning

### FINS

3x soft, replaceable PU 100mm fins

REPLACEMENT FINS AVAILABLE

### BACK BOTTOM SHAPE

Double concave for increased speed

### TAIL SHAPE

Square tail for stability and performance



### NEW SURF SCHOOL SOFTBOARD 6'0"

ZBSSB

Volume: 45.8L  
Length: 6'0"  
Width: 21"  
Thickness: 2 7/8"  
Weight: 4.2kg



### NEW SURF SCHOOL SOFTBOARD 6'6"

ZBSSB

Volume: 55L  
Length: 6'6"  
Width: 22"  
Thickness: 3"  
Weight: 4.8kg



SURF SCHOOL BOARD



**NEW**  
**SURF SCHOOL**  
**SOFTBOARD 7'0"**

ZBSSB

Volume: 71.3L  
Length: 70"  
Width: 23"  
Thickness: 3 1/2"  
Weight: 5.6kg



**NEW**  
**SURF SCHOOL**  
**SOFTBOARD 7'6"**

ZBSSB

Volume: 78.2L  
Length: 7'6"  
Width: 23 1/2"  
Thickness: 3 1/2"  
Weight: 6.0kg



**NEW**  
**SURF SCHOOL**  
**SOFTBOARD 8'0"**

ZBSSB

Volume: 94.3L  
Length: 8'0"  
Width: 24"  
Thickness: 3 3/4"  
Weight: 6.8kg



**NEW**  
**SURF SCHOOL**  
**SOFTBOARD 8'6"**

ZBSSB

Volume: 106.6L  
Length: 8'6"  
Width: 24 1/2"  
Thickness: 3 7/8"  
Weight: 7.5kg



**NEW**  
**SURF SCHOOL**  
**SOFTBOARD 9'0"**

ZBSSB

Volume: 113L  
Length: 9'0"  
Width: 24 1/2"  
Thickness: 4"  
Weight: 8.0kg



**NEW**  
**SURF SCHOOL**  
**SOFTBOARD 10'0"**

ZBSSB

Volume: 128L  
Length: 10'0"  
Width: 25"  
Thickness: 4"  
Weight: 9.5kg



# SSB

The Super Wide Surf School Board has been designed by former World No.5 Phil Macdonald, as the ultimate board for the beginner surfer. Designed using the same construction as the SSB board, the Super Wide SSB board gives the ultimate stability so all levels of beginners can stand up and enjoy surfing quicker. With added width, thickness and lower rocker the Super Wide SSB is the perfect beginner board for all learners no matter what weight and height.

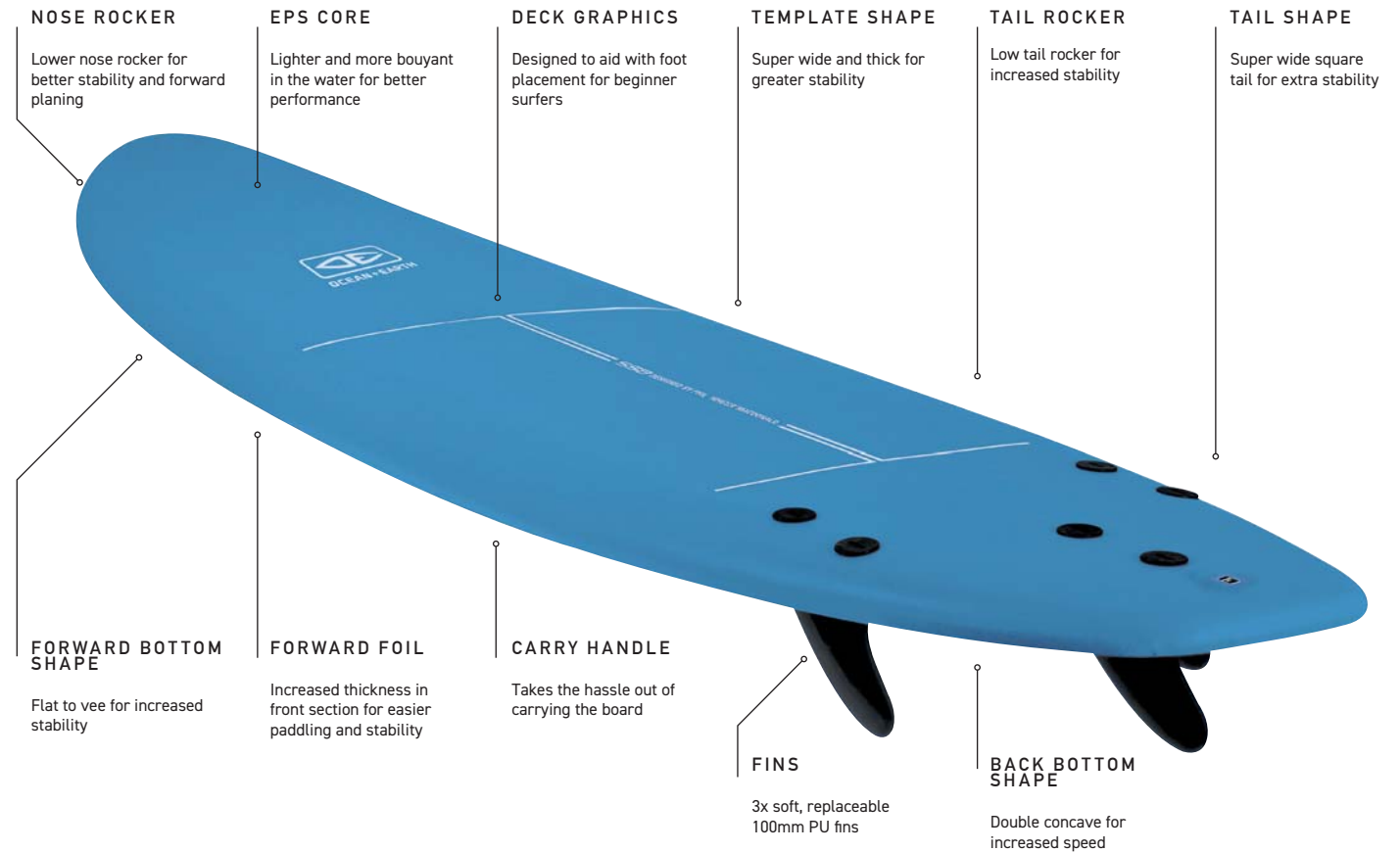



**NEW**  
**SUPER WIDE**  
**SURF SCHOOL SOFTBOARD 7'0"**

ZBWSB

Volume: 97.7L  
Length: 7'0"  
Width: 25 1/2"  
Thickness: 4"

■  
TEAL



**NEW**  
**SUPER WIDE**  
**SURF SCHOOL SOFTBOARD 8'0"**

ZBWSB

Volume: 117.8L  
Length: 8'0"  
Width: 26 1/2"  
Thickness: 4"

■  
TEAL



**NEW**  
**SUPER WIDE**  
**SURF SCHOOL SOFTBOARD 9'0"**

ZBWSB

Volume: 141L  
Length: 9'0"  
Width: 28"  
Thickness: 4 1/4"

■  
TEAL



# SOFTBOARD FINS + COMPONENTS

All components purchased as single units.  
Material : Polycarbonat

## HOW TO IDENTIFY WHICH FINS TO ORDER

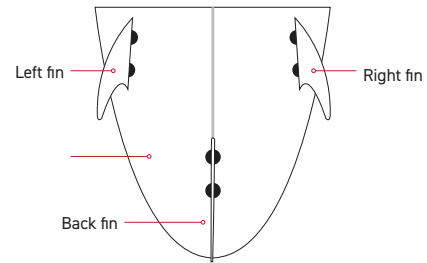

View from bottom of board at tail



**THRUSTER BOX FIN - 4.5"**  
FOR EZI-RIDERS  
BH02



## POLYCARBONATE THRUSTER

A balanced all-round fin



**TWIN BOX FIN - 5.5"**  
FOR EZI-RIDERS  
BH28



**SOFT EDGE TWIN FIN - 5.5"**  
BH34S - SINGLE TAB

## SINGLE TAB



BH30S  
BH30S  
BH30S

SMALL  
MEDIUM  
LARGE

## DUAL TAB



BH30D  
BH30D  
BH30D

SMALL  
MEDIUM  
LARGE

CONSTRUCTION: POLYCARBONATE



**SURF SCHOOL BOARD BACK FIN - 4.0"**  
BH05



**SURF SCHOOL BOARD SIDE FIN - 4.0"**  
BH06



**BUG BOLT-THRU SMALL FIN - 3.25"**  
BH01



**CRUISER SINGLE FIN - 9.0"**  
BH12



**CRUISER SUP THRUSTER  
SIDE FIN-LEFT - 3.5"**  
BH13L



**CRUISER SUP THRUSTER  
SIDE FIN-RIGHT - 3.5"**  
BH13R



**HAPPY HOUR SINGLE FIN - 8.0"**  
BH37



**HAPPY HOUR SINGLE FIN - 9.0"**  
BH38



**HAPPY HOUR SIDE FIN - RIGHT - 3.5"**  
BH39SR



**HAPPY HOUR SIDE FIN - LEFT - 3.5"**  
BH39SL



**ZERO BOLT-THRU SIDE FIN - 4.5"**  
BH03



**ZERO BOLT-THRU BACK FIN - 4.5"**  
BH04



**SQUEEZE SUP AIR VENT VALVE**  
BH10



**CRUISER SUP AIR VENT VALVE**  
BH11

# WETSUITS

FLEX | WARMTH | COMFORT





## DOUBLE BLACK

All O&E Double Black wetsuits are constructed using premium grade Ultra 360° Super Stretch neoprene in all panels. More flex = less resistance, resulting in all round performance.

## FREEFLEX

The new range of Free-Flex wetsuits provide all the quality, flexibility and warmth required for everyday surfing at a value price point. Stretch and value where you need it.

## HERITAGE

The new Heritage Series is constructed with everything you need in a modern wetsuit (Ultra-360 super stretch, front and back smooth skin) combined with heritage styling and paneling.

## DOUBLE BLACK

FLEX | WARMTH | ALL ROUND PERFORMANCE

All O&E Double Black wetsuits are constructed using premium grade Ultra 360° Super Stretch neoprene in all panels. More flex = less resistance, resulting in all round performance.

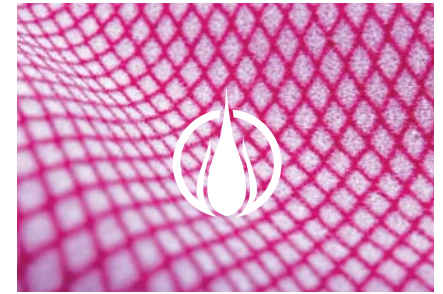

**HYDRO PLUSH QUICK DRY LINING**  
Quick drying, warm, comfortable fuzz around your vital organs. Where you need it most.

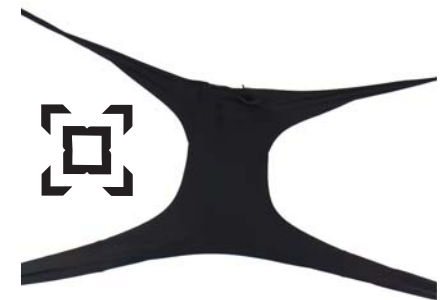

**360 ULTRA STRETCH NEO**  
All over premium grade super stretch neoprene. More flex - Less resistance = High Performance surfing.



**GBS + WATER SHIELD TAPED SEAMS**  
Fully taped 3 way sealed seam .  
Glued and Blind Stitched internal Water Shield taped seams. Maximises warmth, strength and stretch.  
Minimises water entry.



**DOUBLE BLACK**  
**4/3MM CHEST ZIP STEAMER**

SMWE11

SIZES:	XS, S, M, MT, L, XL, 2XL
WARRANTY:	12 Months



INSIDE

- All over Ultra 360 Super Stretch
- Fully taped 3-way sealed seams:
  - 1: Glued
  - 2: Blind stitched
  - 3: Internal water shield taping
- Reinforced spot tape on stress points
- Hydro Plush Quick Dry lining

**DOUBLE BLACK**  
**3/2MM CHEST ZIP STEAMER**

SMWE01

SIZES:	XS, S, M, MT, L, XL, 2XL
WARRANTY:	12 Months



INSIDE

- All over Ultra 360 Super Stretch
- Fully taped 3-way sealed seams:
  - 1: Glued
  - 2: Blind stitched
  - 3: Internal water shield taping
- Reinforced spot tape on stress points
- Hydro Plush Quick Dry lining

**NEW**

**DOUBLE BLACK**  
**2MM S/S CHEST ZIP STEAMER**

SMWE02

SIZES:	XS, S, M, MT, L, XL, 2XL
WARRANTY:	12 Months



INSIDE

- All over 360 Super Stretch
- Fully Taped 3 way sealed seams:
  - 1: Glued
  - 2: Blind stitched
  - 3: Internal water shield taping
- Reinforced spot tape on stress points
- Hydro Plush Quick Dry lining

# FREEFLEX

FLEX | WARMTH | VALUE

The new range of Free-Flex wetsuits provide all the quality, flexibility and warmth required for everyday surfing at a value price point. Stretch and value where you need it.



#### AQUA PLUSH LINING

Warm, comfortable fuzz around your vital organs where you need it most.



#### ULTRA 360 SUPER STRETCH (UPPER BODY/ ARMS)

Premium grade super stretch neoprene in upper body.  
More Flex- Less Resistance = More Performance in the surf.

#### W1 NEOPRENE (BODY)

Highly durable construction all round performance.



#### GBS + WATER SHIELD TAPED SEAMS

Fully taped 3 way sealed seam.  
Glued and Blind Stitched internal Water Shield taped seams. Maximises warmth, strength and stretch.  
Minimises water entry.



BLACK / CHARCOAL



BLACK / CHARCOAL



BLACK / CHARCOAL

**FREEFLEX**

**5/4MM CHEST ZIP  
HOODED STEAMER**

SMWE46

SIZES:	XS, S, M, MT, L, XL, 2XL
WARRANTY:	12 Months

- BODY: W1 Neoprene
- UPPER BODY: Ultra 360 Super Stretch Neoprene
- Fully taped 3 way sealed seams
  - 1: Glued
  - 2: Blind stitched
  - 3: Water Shield tape
- Reinforced spot taping on stress points
- Aqua Plush lining
- Built in hood



INSIDE

**FREEFLEX**

**4/3MM CHEST ZIP STEAMER**

SMWE42

SIZES:	XS, S, M, MT, L, XL, 2XL
WARRANTY:	12 Months

- BODY: W1 Neoprene
- UPPER BODY: Ultra 360 Super Stretch Neoprene
- GBS : Glued Blind Stitched
- Water Shield tape in crotch & knees
- Reinforced spot taping on stress points
- Aqua Plush lining



INSIDE

**FREEFLEX**

**3/2MM CHEST ZIP STEAMER**

SMWE35

SIZES:	XS, S, M, MT, L, XL, 2XL
WARRANTY:	12 Months

- BODY: W1 Neoprene
- UPPER BODY: Ultra 360 Super Stretch Neoprene
- GBS : Glued Blind Stitched
- Water Shield tape in crotch & knees
- Reinforced spot taping on stress points
- Aqua Plush lining



INSIDE



BLACK / CHARCOAL



BLACK / CHARCOAL



BLACK / CHARCOAL



**3/2MM BACK ZIP STEAMER**

SMWE47

SIZES:	XS, S, M, MT, L, XL, 2XL
WARRANTY:	12 Months

- BODY: W1 Neoprene
- UPPER BODY : Ultra 360 Super Stretch Neoprene
- GBS : Glued Blind Stitched
- Water Shield tape in crotch & knees
- Reinforced spot taping on stress points
- Aqua Plush lining



**2MM CHEST ZIP S/S STEAMER**

SMWE36

SIZES:	XS, S, M, MT, L, XL, 2XL
WARRANTY:	12 Months

- BODY: W1 Neoprene
- UPPER BODY : Ultra 360 Super Stretch Neoprene
- GBS : Glued Blind Stitched
- Water Shield tape in crotch & knees
- Reinforced spot taping on stress points
- Aqua Plush lining



**2MM CHEST ZIP L/S SPRING**

SMWE54

SIZES:	XS, S, M, L, XL, 2XL
WARRANTY:	12 Months

- BODY: W1 Neoprene
- UPPER BODY : Ultra 360 Super Stretch Neoprene
- GBS : Glued Blind Stitched
- Water Shield tape in crotch
- Reinforced spot taping on stress points



BLACK / CHARCOAL

**FREEFLEX**

**2MM BACK ZIP S/S SPRING**

SMWE45

SIZES:	XS, S, M, L, XL, 2XL
WARRANTY:	12 Months

- BODY: W1 Neoprene
- UPPER BODY: Ultra 360 Super Stretch Neoprene
- Flat lock seams





OCEAN & EARTH  
HERITAGE COLLECTION

A throwback to our heritage and  
the golden days of surfing.  
When line ups were empty and  
boards were designed to simply glide.  
Some things change but  
one thing remains the same ...  
**SURF YA LIFE AWAY**



**HERITAGE**  
**2MM BACK ZIP SHORT JOHN**

SMWE53

SIZES:	XS, S, M, L, XL, 2XL
WARRANTY:	12 Months

- 2mm Flat locked seams
- Heritage styling and panelling
- Ultra 360 Super Stretch
- Front and back smooth skin



BACK



**HERITAGE**  
**1.5MM FRONT ZIP VEST**

SMWE51

SIZES:	XS, S, M, L, XL, 2XL
WARRANTY:	12 Months

- 1.5mm Flat locked seams
- Heritage styling and panelling
- Gusset : Ultra 360 Super Stretch
- Front and back smooth skin
- Back scooped hem



BACK



**HERITAGE**  
**1.5MM BACK ZIP L/S VEST**

SMWE52

SIZES:	XS, S, M, L, XL, 2XL
WARRANTY:	12 Months

- 1.5mm Flat locked seams
- Heritage styling and panelling
- Arms/Gusset : Ultra 360 Super Stretch
- Front smooth skin
- Back scooped hem



BACK

# YOUTH WETSUITS

*FREEFLEX*

FLEX | WARMTH | VALUE



YOUTH WETSUITS



BLACK / LIME



BLACK / LIME



BLUE / LIME



BLACK / LIME



BLUE / LIME

**FREEFLEX**

**YOUTH 4/3MM BZ STEAMER**

SBWE54

SIZES:	6, 8, 10, 12, 14, 16
WARRANTY:	12 Months

- BODY: W1 Neoprene
- UPPER BODY : Ultra 360 Super Stretch Neoprene
- GBS : Glued Blind Stitched
- Water Shield tape in crotch & knees
- Reinforced spot taping on stress points
- Aqua Plush lining

**FREEFLEX**

**YOUTH 3/2MM BZ STEAMER**

SBWE47

SIZES:	4, 6, 8, 10, 12, 14, 16
WARRANTY:	12 Months

- BODY: W1 Neoprene
- UPPER BODY : Ultra 360 Super Stretch Neoprene
- GBS : Glued Blind Stitched
- Water Shield tape in crotch & knees
- Reinforced spot taping on stress points
- Aqua Plush lining

**FREEFLEX**

**YOUTH 2MM BZ SPRINGSUIT**

SBWE37

SIZES:	4, 6, 8, 10, 12, 14, 16
WARRANTY:	12 Months

- BODY: W1 Neoprene
- UPPER BODY : Ultra 360 Super Stretch Neoprene
- Flat lock seams



BLACK



BLACK



BLACK

**DOUBLE BLACK**

**1.5MM VEST**

SMRS15

SIZES:	XS, S, M, L, XL, 2XL
WARRANTY:	12 Months



BACK

**DOUBLE BLACK**

**1.5MM S/S VEST**

SMRS13

SIZES:	XS, S, M, L, XL, 2XL
WARRANTY:	12 Months



BACK

- 1.5mm Ultra 360 Super Stretch Neoprene
- Warm, internal plush lining
- Streamlined panelling for best fit
- Flat Lock stitch
- Full length underarm gusset
- No underarm seams = less irritation

**DOUBLE BLACK**

**1.5MM L/S VEST**

SMRS14

SIZES:	XS, S, M, L, XL, 2XL
WARRANTY:	12 Months



BACK

- 1.5mm Ultra 360 Super Stretch Neoprene
- Warm, internal plush lining
- Streamlined panelling for best fit
- Flat Lock stitch
- Full length underarm gusset
- No underarm seams = less irritation



BLACK



BLACK

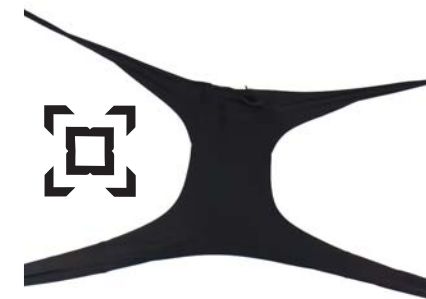

**360 ULTRA STRETCH NEO**

All over premium grade super stretch neoprene. More flex - Less resistance = High Performance surfing.

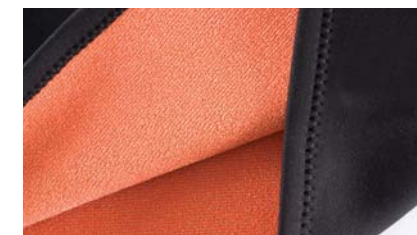

WARM. PLUSH INTERNAL LINING

**DOUBLE BLACK**

**1.5MM FRONT ZIP VEST**

SMWE12

SIZES:	XS, S, M, L, XL, 2XL
WARRANTY:	12 Months

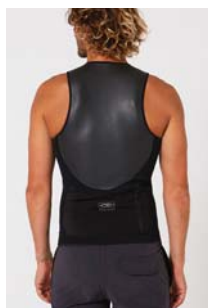

BACK

- 1.5mm Ultra 360 Super Stretch Neoprene
- Smooth skin in back panel
- Warm, internal plush lining
- Back stash pocket with zip closure
- Front zip entry
- Streamlined panelling for best fit
- Flat Lock stitch

**DOUBLE BLACK**

**1.5MM L/S FRONT ZIP VEST**

SMWE13

SIZES:	XS, S, M, L, XL, 2XL
WARRANTY:	12 Months

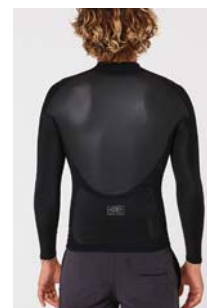

BACK

- 1.5mm Ultra 360 Super Stretch Neoprene
- Smooth skin in back panel
- Stretchy blend of Nylon / Elastane under arms
- Warm, internal plush lining
- Back stash pocket with zip closure
- Front zip entry
- Streamlined panelling for best fit
- Flat Lock stitch

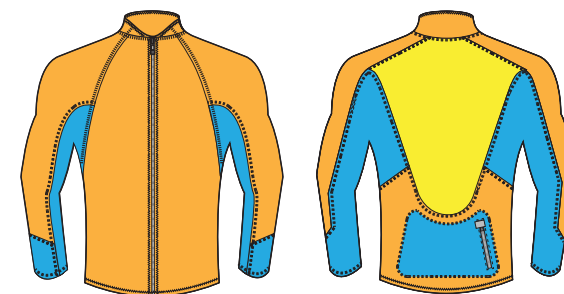

- 1.5mm Ultra 360 Super Stretch Neoprene
- 1.5mm Wind Resistant Smooth Skin
- Supa-Stretchy Nylon / Elastane Blend

# FLAME THERMO SKINS

The perfect thermal base layer providing extra warmth for under wetsuits. Other uses, wear as a paddle shirt or for summer surfing.



## THERMAL INSULATION POLYFLEECE

Produces extra warmth and less wind chill. Plush lining to keep body core temp warm, super stretch for high performance.



BLACK



## FLAME THERMO VEST

MENS

SMRS34  
Sizes: S, M, L, XL, 2XL, 3XL



BLACK



### FLAME THERMO S/S SKIN

MENS

**SMRS25**  
Sizes: S, M, L, XL, 2XL, 3XL

BOYS

**SBRS25**  
Sizes: 4, 6, 8, 10, 12, 14, 16



BLACK



### FLAME THERMO L/S SKIN

MENS

**SMRS26**  
Sizes: S, M, L, XL, 2XL, 3XL

BOYS

**SBRS26**  
Sizes: 4, 6, 8, 10, 12, 14, 16



CHARCOAL

### RIB GUARD PADDED VEST

SMRS24

Sizes: XS, S, M, L, XL, 2XL  
Colours: Charcoal

#### FEATURES:

- Padded, lightweight neoprene foam chest panels
- Flat locked seams
- Made from high quality Nylon /Elastane
- Boardshort anchor loop



CHARCOAL

### RIB GUARD PADDED L/S

SMRS29

Sizes: XS, S, M, L, XL, 2XL  
Colours: Charcoal

#### FEATURES:

- Padded, lightweight neoprene foam chest panels
- UPF 50+ UV protection
- Flat locked seams
- Made from high quality Nylon /Elastane
- Boardshort anchor loop
- 60mm neck height
- Long sleeves for added sun protection

# WOMEN'S WETSUITS

**FREEFLEX**

FLEX | WARMTH | VALUE

Everyday surfing at a value price point. Stretch and value where you need it. The perfect suit for all round performance.



BLACK



BLACK

**FREEFLEX**

## 4/3MM CHEST ZIP STEAMER

SLWE12

## 3/2MM CHEST ZIP STEAMER

SLWE11

SIZES:	4, 6, 8, 10, 12, 14, 16
WARRANTY:	12 Months

- BODY: W1 Neoprene
- UPPER BODY : Ultra 360 Super Stretch Neoprene
- GBS : Glued Blind Stitched
- Water Shield tape in crotch & knees
- Reinforced spot taping on stress points
- Aqua Plush lining



INSIDE

**FREEFLEX**

## 3/2MM BACK ZIP STEAMER

SLWE13

SIZES:	4, 6, 8, 10, 12, 14, 16
WARRANTY:	12 Months

- BODY: W1 Neoprene
- UPPER BODY : Ultra 360 Super Stretch Neoprene
- GBS : Glued Blind Stitched
- Water Shield tape in crotch & knees
- Reinforced spot taping on stress points
- Aqua Plush lining



INSIDE



BLACK



BLACK



BLACK

**FREEFLEX**

**2MM BOYLEG L/S WETSUIT**

SLWE09

SIZES:	6, 8, 10, 12, 14, 16
WARRANTY:	12 Months



INSIDE

- Back zip
- BODY: W1 Neoprene
- UPPER BODY : Ultra 360 Super Stretch Neoprene
- GBS : Glued Blind Stitched
- Streamlined panelling for comfort fit

**FREEFLEX**

**2MM HI CUT L/S WETSUIT**

SLWE02

SIZES:	6, 8, 10, 12, 14
WARRANTY:	12 Months



INSIDE

- Front zip
- 360 Ultrastretch neoprene all over
- Flatlock stitched seams
- Streamlined panelling for comfort fit

**FREEFLEX**

**1.5MM L/S FRONT ZIP PADDLE VEST**

SLWE04

SIZES:	6, 8, 10, 12, 14, 16
WARRANTY:	12 Months



BACK STASH POCKET

- Front zip entry
- 360 Ultrastretch neoprene in arms
- Stretchy blend of Nylon / Elastane under arms
- Back stash pocket with zip closure
- Flat Lock stitch
- Streamlined panelling for best fit

# H O O D S



BLACK



BLACK



BLACK



BLACK

## **ONE DRY SEAL**

### **FULL HOOD 3.0**

SMWE27

SIZES:	S, M, L, XL
WARRANTY:	12 Months

- Ultra 360 Super Stretch Neoprene
- Smooth Skin Ultra Stretch neoprene outer heat absorbing and wind resistance
- Hydro Plush quick dry internal lining for extra warmth
- Dry Seal neck skirt to reduce flushing
- GBS + WaterShield taped seams
- Smooth skin face seal with adjustable elastic cord
- Raised internal ear panels - Increases hearing ability and reduces air voids around ear
- Engineered chin cup
- Flex Peak - No resistance when duck diving

## **FREEFLEX**

### **FULL HOOD 2.0**

SMWE50

SIZES:	S, M, L, XL
WARRANTY:	12 Months

- Ultra 360 Super Stretch Neoprene
- Smooth Skin Ultra Stretch neoprene outer heat absorbing and wind resistance
- Aqua Plush internal lining for extra warmth
- GBS. Glued and blind-stitched
- Raised internal ear panels - Increases hearing ability and reduces air voids around ear
- Engineered chin cup
- Smooth skin external panel
- Flex peak - no resistance when duck diving

## **FREEFLEX**

### **'EASY HEAR' HOOD 2.0**

SMWE20

SIZES:	S/M, L/XL
WARRANTY:	12 Months

- Smooth Skin Ultra 360 Stretch neoprene outer heat absorbing and wind resistance
- Aqua Plush internal lining for extra warmth
- GBS. Glued and blind-stitched
- Adjustable Chin Strap- Added comfort and secure
- Comfort Shape - Panelled and designed for the best fit
- Flex Peak - no resistance when duck diving
- Raised Perforated Internal Ear Panel: Provides clearance from outer hood fabric, which allows better hearing.

## **FREEFLEX**

### **MITTEN 5.0**

SMWE48

SIZES:	S, M, L, XL,
WARRANTY:	12 Months

- W1 Neoprene + Ultra 360 Super Stretch Neoprene
- GBS. Glued and blind-stitched
- External liquid tape
- Dry Seal Opening
- Raised rubber print on palms to grip surfboard

G L O V E S



BLACK

**ONE DRY SEAL**

**GLOVE 3.0**

SMWE28

SIZES:	S, M, L, XL,
WARRANTY:	12 Months

- W1 Neoprene + Ultra 360 Super Stretch Neoprene
- Hydro Plush quick dry internal lining for extra warmth
- GBS. Glued and blind-stitched
- Internal water shield taped seams
- External liquid tape
- Dry seal opening
- Raised rubber print on palms to grip surfboard



BLACK

**FREEFLEX**

**GLOVE 2.0**

SMWE25

SIZES:	S, M, L, XL
WARRANTY:	12 Months

- W1 Neoprene + Ultra 360 Super Stretch Neoprene
- GBS. Glued and blind-stitched
- Raised Rubber print on palms to grip surf board





BLACK

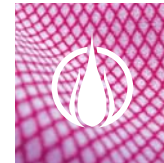

Hydro Plush lining for extra warmth. Taped, glued & blind stitched



Ergonomic ankle crank strap - secure streamline fit



Dry seal sleeve on opening with silicon traction print prevents flushing & grips to your wetsuit.



Heel pull tab. Easy on / off

**ONE DRY SEAL**

**BOOTIE 3.0**

SAB029

- W1 Neoprene + Ultra 360 Super Stretch Neoprene
- Glued and Blind Stitched internal Water Shield taped seams
- Hydro Plush internal lining for extra warmth
- Ergonomic ankle crank strap - secure streamline fit
- Dry Seal sleeve on opening - reduces flushing
- Split toe design for added mobility, foot stability & grip
- Textured, reef resistant sole
- Heel pull tab - easy on / off

XS: shoe size 6  
S: shoe size 7-8  
M: shoe size 8-9  
L: shoe size 9-10  
XL: shoe size 10-12  
2XL: shoe size 12-13

BOOTIES



BLACK



BLACK



BLACK



2X crank straps for secure fit



Taped, glued & Blind stitched internal seams.



Heel pull tab. Easy on / off



2X crank straps for secure fit



Taped, glued & Blind stitched internal seams.



Heel pull tab. Easy on / off

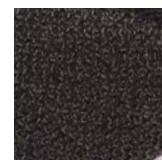

Tough Oxy Mesh textured sole for traction



Taped, glued & Blind stitched internal seams.



Dry seal sleeve on opening



**BOOTIE 5.0**

SAB003

- W1 Neoprene + Ultra 360 Super Stretch Neoprene
- Glued and Blind Stitched internal Water Shield taped seams
- Split toe design for added mobility, foot stability & grip
- Reinforced toes
- Full length height
- Dual crank straps

XS: shoe size 6  
S: shoe size 7-8  
M: shoe size 8-9  
L: shoe size 9-10  
XL: shoe size 10-12  
2XL: shoe size 12-13



**BELLS BOOTIE 3.0**

SAB002

- W1 Neoprene + Ultra 360 Super Stretch Neoprene
- Glued and Blind Stitched internal Water Shield taped seams
- Split toe design for added mobility, foot stability & grip
- Reinforced toes
- Full length height
- Dual crank straps

XS: shoe size 6  
S: shoe size 7-8  
M: shoe size 8-9  
L: shoe size 9-10  
XL: shoe size 10-12  
2XL: shoe size 12-13



**SLIPPER 2.0**

SAB004

- W1 Neoprene + Ultra 360 Super Stretch Neoprene
- Glued and Blind Stitched internal Water Shield taped seams
- Split toe design for added mobility, foot stability & grip
- Dry Seal sleeve on opening - reduces flushing
- Tough Oxy Mesh - textured sole for traction
- Flexible sole design for a 'no boot' feel

XS: shoe size 6  
S: shoe size 7-8  
M: shoe size 8-9  
L: shoe size 9-10  
XL: shoe size 10-12  
2XL: shoe size 12-13



BLACK



2X crank straps for secure fit

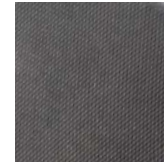

Tough, textured sole for traction



Adjustable shock cord

**FREE FLEX**  
**JAVA BOOTIE 1.5**  
SAB001

- W1 Neoprene + Ultra 360 Super Stretch Neoprene
- Flatlock stitch
- Split toe construction allows added mobility and gives better foot stability
- Drainage holes
- Reinforced toes
- Hi-top design gives added ankle protection against the reef

XXS: shoe size 5  
XS: shoe size 6  
S: shoe size 7-8  
M: shoe size 8-9  
L: shoe size 9-10  
XL: shoe size 10-12  
2XL: shoe size 12-13

B O O T I E S



BLACK



BLACK



RED



Folds Away to Pocket Size

POCKET REEF BOOTIE

SMWE41

**PRE SURF:** Ideal for walking to the line up across sharp shallow reef.

**SURF:** Easily fold the "Pocket Reef Bootie" up and slip them into your boardie pocket if you choose not to surf with them.

**POST SURF:** Slip the "Pocket Reef Bootie" back on and cruise back to shore.

- Lightweight 1mm neoprene
- Thin rubber sole- grippy and resistant to cuts and tears
- Comes in a mesh storage bag

XS: shoe size 6  
S: shoe size 7-8  
M: shoe size 8-9  
L: shoe size 9-10  
XL: shoe size 10-12  
2XL: shoe size 12-13

REEF WALKER BOOTIE

SMWE40

The Reef Walker Bootie is ideal for walking over reefs in and around the ocean. The rubber sole will help protect your feet from sharp coral reef cuts and abrasions.

- Lightweight 1mm neoprene
- Rubber sole- grippy and resistant to cuts and tears
- Ventilated Mesh upper - A breathable material designed to increase air flow around your feet
- Comes in a mesh storage bag

XS: shoe size 6  
S: shoe size 7-8  
M: shoe size 8-9  
L: shoe size 9-10  
XL: shoe size 10-12  
2XL: shoe size 12-13

SLIDE ON WETTY SLIPPERS

SMWE34

- Lightweight nylon ripstop fabric
- Slide into a tight fitting or wet wetsuit with ease.
- Use on both legs and arms



### HIGH N' DRY WETTY BUCKET

AMMC55

#### COLLAPSIBLE WETTY BUCKET

- Tough Waterproof fabric
- 55mm thick closed cell foam in the base of bucket
- Adjustable webbing shoulder strap (adjusts to 115cm)
- Welded seams
- Collapsible when not in use



#### FOAM BLOCK BASE

Foam block base has multiple holes throughout. Each hole is designed to hold excess water from wet wetsuits between surfs. Helps keep your wetty "high n dry"

### COMPACT WETTY BUCKET

AMMC54

#### COLLAPSIBLE WETTY BUCKET TOUGH WATERPROOF FABRIC WITH WELDED SEAMS

- Smaller bucket that still holds large size steamer
- Collapses when not in use

### WETSUIT CHANGE MAT

AMMC22

- Tough, waterproof fabric
- Quick release drawstring / toggle
- Carry / tightening handles
- Stash pocket for sunscreen / fin keys etc.
- Stand inside to prevent sand and dirt messing up your wetty



WETSUIT ACCESSORIES



DRY SEAT COVER

AMMC23

- Designed for use for all watersports
- Tough, waterproof material protects car seats from water, sunscreen, etc
- Install & remove in seconds
- Fits most car / van seats (excludes seats that house air bags)
- Stay warm in your wet gear until you hit the hot shower



QUICK DRY WETSUIT HANGER

AMMC28

- Increased airflow results in a quicker drying time
- Perfect for storage while you're not surfing
- Reduces mould build up



WETSUIT ACCESSORY HANGER

AMMC37

- Increased airflow results in a quicker drying time
- Designed for a pair of boots, gloves and a hood
- Multiple hanging options. Use either the hanging hook or adjustable strap with webbing loop to hang your gear almost anywhere. Optimise drying time, then use the hanger to store everything together in one place



WETSUIT DRYING RACK

AMMC43

- Free standing mobile rack for drying wetsuits, rash shirts and wetsuit accessories
- Perfect for drying your gear if living in apartment style housing or where space is limited.
- Removable wetsuit tray included catches water when drying and also doubles as a wetsuit bucket for car use.
- Max load rating 60kgs

- Rack size
- Height (adjustable): 1600mm - 2000mm
  - Width: 520mm
  - Base: 720mm x 520mm.

Product includes metal rack and waterproof drying bucket. Picture above is to demonstrate use.

# LYCRA

High quality lycra sun protection. Streamlined panelling for the best fit, providing comfort and freedom of movement.



MIDNIGHT INK



WHITE



BLACK



CHARCOAL

## SCRIPT S/S RASH SHIRT

MENS

SMRS06

Sizes: S, M, L, XL, 2XL, 3XL

### FEATURES:

- UPF 50+ UV Protection
- Flat locked seams
- Boardshort anchor loop
- 60mm neck height
- Made from high quality Nylon/ Elastane



WHITE



NAVY MARLE



OLIVE MARLE

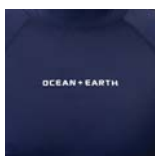

MIDNIGHT INK

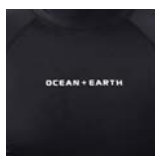

BLACK



CHARCOAL



GREY MARLE

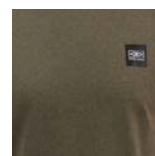

OLIVE MARLE



GREY MARLE

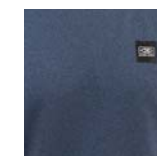

NAVY MARLE

## SCRIPT L/S RASH SHIRT

**SMRS22**

Sizes: S, M, L, XL, 2XL, 3XL

MENS

### FEATURES:

- UPF 50+ UV Protection
- Flat locked seams
- Long sleeves for added sun protection
- Boardshort anchor loop
- 60mm neck height
- Made From high quality Nylon / Elastane

## S/S SURF SHIRT

**SMRS31**

Sizes: S, M, L, XL, 2XL, 3XL

MENS

### FEATURES:

- UPF 50+ UV Protection\*
- Flat locked seams
- Comfortable loose fit
- Suitable to wear in and out of the water
- Made from high quality Nylon/Elastane

\*Grey Marle UPF 30+ UV Protection

## L/S SURF SHIRT

**SMRS32**

Sizes: S, M, L, XL, 2XL, 3XL

MENS

### FEATURES:

- UPF 50+ UV Protection\*
- Flat locked seams
- Long sleeves for added sun protection
- Comfortable loose fit
- Suitable to wear in and out of the water
- Made from high quality Nylon/Elastane

\*Grey Marle UPF 30+ UV Protection

MENS & BOYS LYCRA



CHARCOAL

BLACK

BLACK

ROYAL

NAVY

TROPIC HOODED L/S RASHIE

MENS

SMRS33

Sizes: S, M, L, XL, 2XL, 3XL

FEATURES:

- UPF 50+ UV protection
- Hood for sun protection - drawstring closure
- Streamlined panelling
- Thumb holes
- Long sleeves for added sun protection
- Underarm gusset
- Elastic shock cord & toggle
- Stash pocket gusset at back with zip closure
- Flat locked seams
- Boardshort anchor loop
- Made from high quality Nylon/Elastane

ANTI-RASH SURF SHORT

MENS

SMRS10

Sizes: XS, S, M, L, XL, 2XL, 3XL

BOYS

SBRS10

Sizes: 8, 10, 12, 14, 16

FEATURES

- Wear them under boardshorts or wetsuit
- Front gusset and anti-rash ensures comfort freedom and support
- Soft elastic waistband
- Side seam free
- Flat locked seams
- Made from high quality Nylon /Elastane

SCUNNO

MENS

SMRS12

Sizes: S, M, L, XL, 2XL

BOYS

SBRS12

Sizes: 6, 8, 10, 12, 14, 16

FEATURES:

- Classic cut brief
- Drawcord waist
- Double lined front panel
- Perfect for smuggling budgies
- Made from high quality Nylon / Elastane

BOYS LYCRA



**NEW** ROYAL BLUE



**NEW** CHARCOAL



**NEW** CHARCOAL



**NEW** ROYAL BLUE

BOYS T-SHIRT FIT S/S RASH SHIRT

**BOYS** SBRS13  
Sizes: 8, 10, 12, 14, 16

**TOD BOYS** STRS13  
Sizes: 2, 4, 6

FEATURES:

- T-Shirt Fit
- UPF 50+ UV Protection
- Flat locked seams
- Made from high quality Nylon/Elastane

BOYS T-SHIRT FIT L/S RASH SHIRT

**BOYS** SBRS14  
Sizes: 8, 10, 12, 14, 16

**TOD BOYS** STRS14  
Sizes: 2, 4, 6

FEATURES:

- T-Shirt Fit
- UPF 50+ UV Protection
- Flat locked seams
- Long sleeves for added sun protection
- Made from high quality Nylon/Elastane



## LADIES LYCRA



REPREVE® is the world's leading brand of recycled performance fiber. Made from plastic bottles and fresh hope, we help you do more with less.

Using recycled instead of virgin polyester produces fewer carbon emissions. And giving plastic bottles a second life keeps them out of oceans and landfills.



**NEW** BLUE



**NEW** HAZELNUT FLOWER



BLACK



BLACK

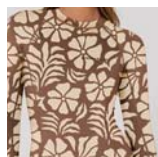

**NEW** HAZELNUT FLOWER

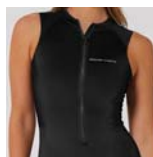

BLACK



**NEW** BLUE



HAZELNUT FLOWER

**OCEANA L/S BZ SURF SUIT** **REPEVE**

LADIES SLRS32

By Size (6-16)

GIRLS SGRS32

By Size (8yr-14yr)

\*Baby Pink, Hazelnut Flower, Black only

- 50+ UV Protection
- Wetsuit style surf suit
- Light internal bust support \*ladies only
- Long sleeves for added sun protection
- Water resistant back zip
- Zip pull cord
- Contoured panelling for shape
- Flat locked seams
- Made from high quality RECYCLED Polyester / Elastane



**BREEZE FZ SURF SUIT** **REPEVE**

LADIES SLRS33

By Size (6-16)

- Sleeveless wetsuit style surf suit
- Light internal bust support
- Water resistant front zip
- Cheeky bottom
- Flat locked seams
- Made from high quality RECYCLED Polyester/Elastane

**NEW**  
**HYAMS BODYSUIT** **REPEVE**

LADIES CLSW009126

By Size (6-16)

- Scoop neckline boyleg bodysuit
- Light internal bust support \*ladies only
- Full bottom coverage
- Low scoop back
- Flat locked seams
- Made from high quality RECYCLED Polyester/Elastane



BLACK



**NEW** HAZELNUT FLOWER



**NEW** BLUE



**NEW** BLUE

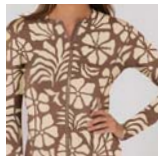

**NEW** HAZELNUT FLOWER



BLACK



**NEW** BLUE



BLACK

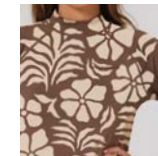

**NEW** HAZELNUT FLOWER

**OCEANA L/S ZIP FRONT** REPEVE

SLRS03

By Size (6-18)

\*18 Black only

- 50+ UV Protection
- Water resistant full length front zip
- Long sleeves for added sun protection
- Contoured panelling for shape
- Flat locked seams
- Made from high quality RECYCLED Polyester / Elastane

**ECLIPSE C/S** REPEVE

LADIES SLRS30

By Size (6-16)

GIRLS SGRS30

By Size (4yr-14yr)



**NEW**



**NEW**

\*Hazelnut Flower, Baby Pink

- 50+ UV Protection
- Contoured panelling for shape
- Flat locked seams
- Made from high quality RECYCLED Polyester / Elastane

**WAVES L/S** REPEVE

LADIES SLRS29

By Size (6-18)

\*18 Black only

- 50+ UV Protection
- Long sleeves for added sun protection
- Contoured panelling for shape
- Flat locked seams
- Made from high quality RECYCLED Polyester / Elastane

GIRLS SGRS29

By Size (4yr-14yr)

\*Hazelnut Flower, Baby Pink



**NEW**



**NEW**



BLACK



**NEW** HAZELNUT FLOWER

## HYAMS HIGH WAIST SURF SHORT

CLSWB07124

By Size (6-16)

- High waisted boy leg surf short
- Full bottom coverage
- Made from high quality RECYCLED Polyester/Elastane





## SURF HATS

Sun protection whilst surfing or doing any water sport is a must for us all to limit the damage caused by UV rays. O&E have the largest most extensive range of technical, sun protective surf caps available. Lightweight, quick-dry materials and secure buckle adjustments result in a comfort fit that won't come off whilst surfing.



This product range comes with plastic free packaging.  
Another step in the right direction to help eliminate single use plastic.

# INDO SERIES

## TECHNICAL FABRIC

Quick-drying, light weight nylon fabric

## ADJUSTABLE FIT

On the back of the hat. For a perfect fit.

## INTERNAL PADDED HEADBAND

Padded neoprene internal headband for comfort

## STIFF BRIM

Maintains clear vision while surfing. Flips up for paddling

## MESH ON EAR PANELS

Protects your ears from sunburn

## PADDED NEOPRENE EAR PANEL & STRAPS

Comfortable and flexible

## ADJUSTABLE CHIN STRAP

Quick release. Adjustable for correct fit



UPF 50+  
Extreme sun protection.  
\*Selected styles only



CHARCOAL



OLIVE

CHARCOAL

PALE LILAC

GREY

BLUE

NAVY

## INDO STIFF PEAK SURF HAT

SMHA02

Sizes:  
XS : 57cm  
S : 58cm  
M : 59cm  
L : 61cm  
XL : 62cm

- Wide brim
- Velcro closure
- Internal stash pocket
- Removable legionnaire flap
- Mesh vents

INDO SERIES



OLIVE



OLIVE

CHARCOAL

PALE LILAC

GREY

BLUE

NAVY

INDO 5 PANEL SURF CAP

SMHA01

Sizes: One size fits most

Velco closure



GREY



GREY

CHARCOAL

INDO 5 PANEL LEGIONNAIRE SURF CAP

SMHA07

Sizes:  
S/M : 58cm  
L/XL : 60cm

- Extra sun protection with fixed legionnaire style neck cover
- Shock cord adjustment

I N D O   S E R I E S



NAVY



NAVY

BLACK

INDO TRUCKER SURF CAP

SMHA04

Sizes: One size fits most

- Snap back closure



# BINGIN SERIES

## TECHNICAL FABRIC

Quick-drying, light weight nylon fabric

## ADJUSTABLE FIT

On the back of the hat. For a perfect fit.

## INTERNAL PADDED HEADBAND

Padded neoprene internal headband for comfort

## SOFT BRIM

Maintains clear vision while surfing. Flips up for paddling

## MESH ON EAR PANELS

Protects your ears from sunburn

## PADDED NEOPRENE STRAPS

Comfortable and flexible

## ADJUSTABLE CHIN STRAP

Quick release. Adjustable for correct fit



UPF 50+

Extreme sun protection.

\* selected styles only



OLIVE



OLIVE

BLACK

BLUE

PALE LILAC

## BINGIN SOFT PEAK SURF HAT

ADULT

SMHA03

Sizes:  
XS : 57cm  
S : 58cm  
M : 59cm  
L : 61cm  
XL : 62cm

YOUTH

SBHA03\*

Size:  
56cm

KIDS

SKHA03\*

Size:  
54cm

- Floating brim
- Elastic cord + toggle closure
- (YOUTH KIDS ONLY) Removable legionnaire style neck cover.

BINGIN SERIES



BLACK



CAMO



SAGE FLOWER



OLIVE

BLACK



NEW SAGE FLOWER

NEW CHESTNUT FLOWER

CAMO

BINGIN STRAP BACK SURF CAP

SMHA08

Sizes:  
S/M : 58cm  
L/XL : 60cm

- Extra Sun Protection with removable legionnaire style neck cover
- Back webbing and clip closure
- Floating EVA foam brim.

BINGIN-LIGHTWEIGHT LEGIONNAIRE SURF CAP

SMHA11

Sizes:  
S/M : 58cm  
L/XL : 60cm

- Technical fabric - lightweight and water repellent
- Floating brim
- Elastic cord + toggle closure
- Extra Sun Protection with removable legionnaire style neck cover.

BINGIN-LIGHTWEIGHT SOFT PEAK SURF HAT

ADULT SMHA12

Sizes:  
XS: 57cm  
S : 58cm  
M : 59cm  
L : 61cm  
XL : 62cm

YOUTH SBHA12

Size  
56cm

KIDS SKHA12

Size  
54cm

- Technical fabric - lightweight and water repellent
- Floating brim
- Elastic cord + toggle closure
- (YOUTH KIDS ONLY) Removable legionnaire style neck cover.

# G-LAND SERIES

## TECHNICAL FABRIC

Quick-drying, light weight nylon fabric

## VELCRO HEAD ADJUSTMENT

For secure fit

## INTERNAL PADDED HEADBAND

Padded neoprene internal headband for comfort

## MESH ON EAR PANELS

Protects your ears from sunburn

## PADDED NEOPRENE STRAPS

Comfortable and flexible

## ADJUSTABLE CHIN STRAP

Quick release. Adjustable for correct fit



UPF 50+

Extreme sun protection.

\* selected styles only



FOREST



STONE

BLACK

FOREST

## G-LAND LEGIONNAIRE SURF CAP

SMHA09

Sizes: One size fits most

- Stiff peak.
- Extra Sun Protection with fixed legionnaire style neck cover for extra coverage
- Velcro closure
- Vintage branding with contrast stitch detail



BLACK



STONE

BLACK

FOREST

## G-LAND SOFT PEAK SURF HAT

SMHA10

Sizes:  
XS : 57cm  
S : 58cm  
M : 59cm  
L : 61cm  
XL : 62cm

- Vintage branding with contrast stitch detail.
- Soft peak.
- Elastic cord + toggle closure.



# YOUTH SURF HATS



OLIVE



OLIVE

BLACK

BLUE

PALE LILAC

## BINGIN SOFT PEAK SURF HAT

YOUTH

SBHA03

Sizes:  
56cm

KIDS

SKHA03

Size:  
54cm

- Floating brim
- Elastic cord + toggle closure
- Removable legionnaire style neck cover.



**NEW** SAGE FLOWER



**NEW** SAGE FLOWER

CAMO

**NEW** CHESTNUT FLOWER

### BINGIN-LIGHTWEIGHT SOFT PEAK SURF HAT

**YOUTH** SBHA12

Sizes:  
56cm

**KIDS** SKHA12

Size  
54cm

- Technical fabric - lightweight and water repellent
- Floating brim
- Elastic cord + toggle closure
- Removable legionnaire style neck cover.



BLUE



NAVY



AQUA



PALE LILAC

### KIDS SUNBREAKER BEACH HAT

ATHA02

Size:  
One size fits most (54 - 56cm)



## FORCES OF NATURE SERIES

A technical & functional collection designed to protect you from the harshest elements our planet can throw at you.



BLACK

### SUPER STORM PONCHO/JACKET

AMTW25  
XS/S, S/M, L/XL

LENGTH FROM SHOULDER XS/S: 100CM

LENGTH FROM SHOULDER S/M: 110CM

LENGTH FROM SHOULDER L/XL: 120CM

WATER RESISTANT OUTER / WARM SHERPA FLEECE INNER

#### • OUTER MATERIAL HD NYLON WITH PU WATER RESISTANT COATING

- Long sleeves with tab cuff
- Fully lined hood
- 2 way heavy duty full zip
- 2 x external patch pockets
- Keeps you warm and dry
- Internal chest zip pocket



BLACK



BLACK

**PERFECT STORM PONCHO** 

AMTW05  
S/M, L/XL

LENGTH FROM SHOULDER S/M: 100CM  
LENGTH FROM SHOULDER L/XL: 110CM  
WATER RESISTANT OUTER / WARM SHERPA FLEECE INNER

- **OUTER MATERIAL HD NYLON WITH PU WATER RESISTANT COATING**
- Oversize arm openings
- Kanga pocket
- Hood cord



BLACK

**ELEMENTS JACKET** 

CMJK04                      CBJK04  
MENS S - 4XL              BOYS 8 - 16

WATER RESISTANT OUTER

- **OUTER MATERIAL HD NYLON WITH PU WATER RESISTANT COATING**
- Wind & Rain Jacket
- Jacket neatly folds away into internal pocket
- External side pockets
- Internal pocket
- Foldaway hood with drawcord and toggle
- Internal waist drawcord and toggle



BLACK

**DAWN BREAKER HOODED PONCHO**

AMTW24  
S/M, L/XL

LENGTH FROM SHOULDER S/M: 100CM  
LENGTH FROM SHOULDER L/XL: 110CM

- **250GSM MICROFIBRE**
- Relaxed fit sleeves
- Full zip opening
- Warm hood
- Hood Cord
- 2 x patch pockets

# PONCHOS

Comfort, warmth and protection when getting changed before and after a surf.



COMMITTED TO  
PLASTIC REDUCTION



DULL BLACK      PETROL

**SURF ESSENTIALS HOODED PONCHO**

AMTW17

LENGTH FROM SHOULDER: 110CM  
230GSM LIGHTWEIGHT BRUSHED POLYESTER BLEND

- Large oversized arm opening
- Warm Hood



DULL BLACK      PETROL

**SURF ESSENTIALS LS HOODED PONCHO**

AMTW27

LENGTH FROM SHOULDER: 108CM  
230GSM LIGHTWEIGHT BRUSHED POLYESTER BLEND

- Relaxed fit long sleeves
- Kanga Pocket
- Zip Patch Pocket
- Warm Hood
- Hood Draw Cord



**NEW**  
DULL BLACK/ORANGE      GREY

**MENS IGNITE HOODED PONCHO**

AMTW29

LENGTH FROM SHOULDER: 110CM  
230GSM LIGHTWEIGHT BRUSHED POLYESTER BLEND

- Side Zip Access
- Relaxed fit tee-shirt-style sleeves
- Printed webbing on pockets and hem
- Kanga Pocket
- Zip Patch Pocket
- Warm hood with internal printed lining
- Hood Drawcord



BLACK      NAVY      TEAL

**MENS TERRY HOODED PONCHO**

AMTW11

LENGTH FROM SHOULDER: 110CM  
315GSM LIGHTWEIGHT UNBRUSHED TERRY TOWELLING

- Large, oversize arm openings
- Warm hood



**PHONE POCKET**

Conveniently secure your phone and valuables in zip closure pocket



MILITARY NAVY BLACK

**MENS CORP HOODED PONCHO**

AMTW12

LENGTH FROM SHOULDER: 110CM  
340GSM COMFY COTTON VELOUR

- Large, oversize arm openings
- Warm hood
- Kanga pocket
- Zip Patch Pocket



**PHONE POCKET**



ASPHALT **NEW** NAVY **NEW** MILITARY

**MENS DAYBREAK HOODED PONCHO**

AMTW13

LENGTH FROM SHOULDER: 110CM  
340GSM COMFY COTTON VELOUR

- Oversize arm openings
- Warm hood with contrast internal panel
- Kanga pocket
- Hood Drawcord
- Zip Patch Pocket



**PHONE POCKET**



**NEW** DUSTY TURQUOISE **NEW** ASPHALT

**MENS HORIZON ZIP NECK HOODED PONCHO**

AMTW33

LENGTH FROM SHOULDER: 110CM  
340GSM COMFY COTTON VELOUR

- Oversize arm openings
- Contrast top panel with neck zip
- Warm hood with drawcord
- Kanga pocket
- Zip patch pocket



CAMO

**MENS REAL CAMO HOODED PONCHO**

AMTW28

LENGTH FROM SHOULDER: 110CM  
230GSM LIGHTWEIGHT BRUSHED POLYESTER BLEND

- Oversize arm openings
- All over digital print
- Zip patch pocket
- Kanga pocket



CHARCOAL SAND DUSK GREEN

**MENS LAYZ HOODED PONCHO**

AMTW18

LENGTH FROM SHOULDER: 110CM  
430GSM 100% COTTON JACQUARD

- Woven Jacquard Stripe
- Oversize Arm Openings
- Warm Hood
- Kanga Pocket



FOG BLACK

**MENS WAFFLE HOODED PONCHO**

AMTW19

LENGTH FROM SHOULDER: 110CM  
250GSM 100% COTTON WAFFLE

- Woven Waffle
- Garment Wash
- Oversize Arm Openings
- Warm Hood
- Kanga Pocket

LADIES  
PONCHOS





NEW

BLACK

## LADIES SUPER STORM PONCHO/JACKET

ALTW36  
SX/S, M/L

LENGTH FROM SHOULDER XS/S: 100CM

LENGTH FROM SHOULDER M/L: 110CM

WATER RESISTANT OUTER / WARM SHERPA FLEECE INNER

• **OUTER MATERIAL HD NYLON WITH PU WATER RESISTANT COATING**

- Long sleeves with tab cuff
- Fully lined hood
- 2 way heavy duty full zip
- 2 x external patch pockets
- Keeps you warm and dry
- External chest zip pocket



PHONE  
POCKET



NEW

NEW

NEW

COTTON CANDY

MUTE MINT

CORN FLOWER

## LADIES HOODED PONCHO

ALTW03

LENGTH FROM SHOULDER: 105CM

340GSM COMFY COTTON VELOUR

- Oversize arm openings
- Warm hood
- Contrast hood drawcord
- Kanga pocket
- Zip Patch Pocket



PHONE  
POCKET



DULL BLACK

WHITE

## LADIES V NECK HOODED PONCHO

ALTW27  
S/M, L/XL

LENGTH FROM SHOULDER S/M: 88CM

LENGTH FROM SHOULDER L/XL: 93CM

80% COTTON / 20% POLY TERRY

- V-neck
- Warm, lined hood with drawcord
- Side pockets



HAZENUT DUSTY TURQUOISE SEASHELL PINK

### LADIES DAYDREAM HOODED PONCHO

ALTW21

LENGTH FROM SHOULDER: 105CM  
340GSM COMFY COTTON VELOUR

- Oversize arm openings
- Warm hood with contrast internal panel
- Large Kanga pocket
- Contrast drawcord and pocket
- Zip Patch Pocket



DUSTY TURQUOISE SEASHELL PINK

### LADIES DUNES HOODED PONCHO

ALTW32

LENGTH FROM SHOULDER: 105CM  
340GSM COMFY COTTON VELOUR

- Yarn dyed stripe
- V-neck
- Oversize arm openings
- Warm hood
- Kanga pocket
- Zip patch pocket





SAND DUSK GREEN COCOA

**LADIES LAYZ HOODED PONCHO**

ALTW19

LENGTH FROM SHOULDER: 105CM  
430GSM 100% COTTON JACQUARD

- Woven Jacquard Stripe
- Oversize Arm Openings
- Warm Hood
- Kanga Pocket
- Hem Tassels



DUSTY TURQUOISE HAZELNUT

**LADIES DAISY ZIP HOODED PONCHO**

ALTW30

LENGTH FROM SHOULDER: 105CM  
230GSM COMFY COTTON VELOUR

- Yarn dyed stripe
- V-neck
- Oversize arm openings
- Warm hood
- Kanga pocket



PEPPERMINT DUST

**LADIES DRIFT HOODED PONCHO**

ALTW31

LENGTH FROM SHOULDER: 105CM  
430GSM 100% COTTON JACQUARD

- Woven jacquard floral
- Oversize arm openings
- Warm hood



BLEACHED AQUA PINK SORBET ANTIQUE WHITE

**LADIES WAFFLE HOODED PONCHO**

ALTW20

LENGTH FROM SHOULDER: 105CM  
250GSM 100% COTTON WAFFLE

- Woven Waffle
- Garment Wash
- Oversize Arm Openings
- Warm Hood
- Kanga Pocket
- Hem Tassels

# YOUTH & TODDLER PONCHOS

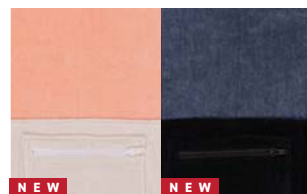

SEASHELL PINK NAVY

## YTH HOODED PONCHO

ABTW06

LENGTH FROM SHOULDER: 90CM  
340GSM COMFY COTTON VELOUR

- Oversize arm openings
- Warm hood
- Kanga pocket
- Zip Patch pocket



PHONE  
POCKET



CAMO

## YTH REAL CAMO HOODED PONCHO

ABTW28

LENGTH FROM SHOULDER: 90CM  
230GSM LIGHTWEIGHT BRUSHED POLYESTER BLEND

- Oversize arm openings
- All over digital print
- Kanga pocket
- Zip Patch Pocket



PHONE  
POCKET



SAND  
FREE  
FABRIC



**NEW** DUSTY TURQUOISE **NEW** ASHPALT

**YTH HORIZON ZIP-NECK HOODED PONCHO**

ABTW33

LENGTH FROM SHOULDER: 90CM  
340GSM COMFY COTTON VELOUR

- Oversize arm openings
- Contrast top panel with neck zip
- Warm hood with drawcord
- Kanga pocket
- Zip patch pocket



**NEW** DUSTY TURQUOISE **NEW** SEASHELL PINK

**YTH DUNES HOODED PONCHO**

ABTW32

LENGTH FROM SHOULDER: 90CM  
340GSM COMFY COTTON VELOUR

- Yarn dyed stripe
- V-neck
- Oversize arm openings
- Warm hood
- Kanga pocket
- Zip patch pocket



**NEW** DUSTY TURQUOISE **NEW** HAZELNUT

**YTH DAISY HOODED PONCHO**

AGTW30

LENGTH FROM SHOULDER: 90CM  
230GSM COMFY COTTON VELOUR

- Yarn dyed stripe
- V-neck
- Oversize arm openings
- Warm hood
- Kanga pocket

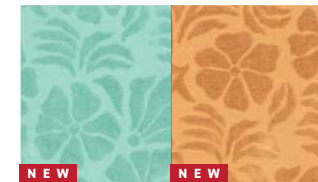

**NEW** PEPPERMINT **NEW** DUST

**YTH DRIFT HOODED PONCHO**

AGTW31

LENGTH FROM SHOULDER: 90CM  
430GSM 100% COTTON JACQUARD

- Woven jacquard floral
- Oversize arm openings
- Warm hood

TODDLERS PONCHOS



NEW DUSTY TURQUOISE SEASHELL

**TODDLERS HOODED PONCHO**

ACTW06

LENGTH FROM SHOULDER: 70CM  
340GSM COMFY COTTON VELOUR

- Oversize arm openings
- Warm hood
- Kangaroo pocket



NEW CAMO

**TODDLER REAL CAMO HOODED PONCHO**

ACTW28

LENGTH FROM SHOULDER: 70CM  
230GSM BRUSHED POLYESTER BLEND

- All over digital print
- Snap button sides
- V-neck
- Warm hood
- Kangaroo pocket



NEW DUSTY TURQUOISE SEASHELL PINK

**TODDLER DUNES HOODED PONCHO**

ACTW32

LENGTH FROM SHOULDER: 70CM  
340GSM COMFY COTTON VELOUR

- Yarn dyed stripe
- Snap button sides
- V-neck
- Warm hood
- Kangaroo pocket



NEW DUSTY TURQUOISE HAZELNUT

**TODDLER DAISY HOODED PONCHO**

ACTW30

LENGTH FROM SHOULDER: 70CM  
230GSM BRUSHED POLYESTER BLEND

- All over digital print
- Snap button sides
- V-neck
- Warm hood
- Kangaroo pocket



TOWELS



**NEW** PETROL



BLACK



**NEW** DUSTY TURQUOISE



**NEW** DUSTY TURQUOISE



**NEW** SEASHELL PINK

HERITAGE TOWEL

AMTW35

SIZE: 150CM X 80CM

WEIGHT: 315GSM COTTON VELOUR

- Heritage logo print
- Hanging loop
- Zip patch pocket



PRIORITY TOWEL

AMTW06

SIZE: 150CM X 80CM

WEIGHT: 315GSM COTTON VELOUR

- Hanging Loop

DUNES TOWEL

AMTW36

SIZE: 150CM X 80CM

WEIGHT: 315GSM COTTON VELOUR

- Yarn dyed stripe
- Hanging loop
- Tassles

## WATERPROOF WETSUIT BAGS

100% waterproof range of wetsuit packs and bags. High quality, soft PVC fabrics and heat welded seams. Seals tight and provides the ultimate in keeping your gear dry when on surf trips or any water based adventures.



BLACK

### WATERPROOF BEACH TOTE BAG

AMMC41

VOLUME: 47 LITRES  
SIZE: 540 x 380 x 230

- Welded waterproof Tarpaulin construction
- "Hands Free" shoulder strap.
- Velcro closure

## WATERPROOF WETSUIT BAGS



BLACK

### WATERPROOF BEACH TOTE BAG - LARGE

AMMC42

VOLUME: 80 LITRES  
SIZE: 620 x 460 x 280

- Welded waterproof Tarpaulin construction
- Wet / Dry Compartments
- "Hands Free" shoulder strap.
- Velcro closure



BLACK

**NEW**  

### ELEMENTS DRY BAG

AMMC45

VOLUME: 5 LITRES  
SIZE: 370 x 290 x 150

- Welded waterproof Tarpaulin construction
- Internal waterproof phone pocket
- Clip closure system



BLACK

### ELEMENTS WETSUIT BACKPACK

AMMC40

VOLUME: 40 LITRES  
SIZE: 700 x 310 x 180

- Welded waterproof Tarpaulin construction
- External waterproof zip pocket
- External mesh pockets
- Internal zip pockets
- Padded back and shoulder straps
- Clip closure system



BLACK

### WATERPROOF TRAVEL LITE BACKPACK

AMMC34

VOLUME: 30 LITRES  
WATERPROOF SEALED SEAMS

- Airtight 3-fold dry seal system
- Ultra light weight durable fabric
- Stashes away in compact carry bag
- Multi use travel pack

## WATERSPORTS PRODUCTS



### SUP BOARD RAIL TAPE

PAD12

PROTECT YOUR SUP RAILS

- 4m length, 60mm wide
- 0.5mm thickness
- Enough tape for 2m on each side of your board
- Transparent
- Extra strong adhesive



### WATERSPORT BUM BAG

AMWA35

HEAT WELDED PVC BUM BAG

- See through to check your valuables
- Ideal for all types of watersports
- Keep valuables with you safe and dry
- Great for SUP paddling / boating



### WATERPROOF KEY POUCH

AMWA37

FITS KEYS, CREDIT CARDS, LOOSE CHANGE  
SIZE: 70MM X 130MM

- Ideal for all types of water sports
- Keep valuables with you safe & dry
- Strong, flexible heat welded TPU construction
- Perfect for Indo reef boat rides



### FLOATING PHONE CASE

AMWA36

FITS MOBILE PHONES  
SIZE: 130MM X 190MM

- Ideal for all types of water sports
- Keep your phone with you safe & dry
- Strong, flexible heat-welded TPU construction with inflated pocket to keep valuables afloat
- Perfect for Indo reef boat rides

## WATERSPORTS PRODUCTS



### ATOLL MASK & SNORKEL

AMMC15

- Large single lens for wide field of vision
- High quality crystal silicone
- High impact frame & lens guard
- Excellent water-tight seal
- Adjustable, non-slip head strap
- Purge valve for easy clearing of snorkel



BLACK

AQUA

### FREE DIVE MASK & SNORKEL

ADULT: AMMC13

YOUTH: ABMC14

- Large single lens for wide field of vision
- Quality clear synthetic Silitec mask
- High impact frame & lens guard
- Excellent water-tight seal
- Adjustable, non-slip head strap



### WIDE VISION SWIM / DIVE GOGGLES

AMMC12

- Wide vision lens, tinted for UV protection
- Quality, clear silicone mask
- High impact frame and lens guard
- Anti-fog
- Excellent water-tight seal
- Adjustable, non-slip head strap



### SWIM GOGGLES

AMMC38

- Anti-fog
- Ultra clear lenses
- Silicone strap and cushion
- Excellent water-tight seal
- Moulded nose piece
- UV protection

**GTS**

## GLOBAL TRAVEL SERIES

Exploration, crossing new terrain, surfing unknown waters. The instinct to travel is a driving part of every surfer's life. Our travel bags & backpacks are always up for the ride.



BLACK

### SUPER SONIC WHEEL BAG

AMTS05

600D Nylon / Polyester Twill

LARGE SIZE WHEEL BAG  
VOLUME: 100 LITRES

- Split-level zip design for easy access
- 3x Internal Packing Cells
- Tough, moulded protective base
- Neoprene padded carry handles
- Retractable handle & compression straps
- High quality inline skate wheels
- Locking zipper heads
- Wet / dry section



BLACK

### BELLS & WHISTLES

AMTS18

600D Nylon / Polyester Twill

XL TOURING PACK WITH DETACHABLE DAY PACK  
VOLUME: 75 LITRES

- Detachable daypack with padded laptop sleeve
- Mesh water bottle pockets
- Passport stash pocket
- Wet / dry compartment
- External load compression straps
- Padded mesh airflow back
- Curved padded shoulder straps
- Shoulder strap stash pocket
- Full harness system
- Felt lined sunnies / phone pocket
- Internal stationery organizer

GLOBAL TRAVEL SERIES



BLACK

**ULTIMATE SURF BACKPACK**

AMB P32

600D Nylon / Polyester Twill

CUSTOM DESIGNED SURF TRAVEL BACKPACK  
VOLUME: 40 LITRES

- Includes FREE Removable waterproof wetsuit bag
- Includes FREE wetsuit change mat + backpack rain cover
- Felt-lined neoprene fin stash pockets
- Tarpee-lined wax / sunscreen pocket
- Expandable drink bottle holders
- Tarpee lined Wet/Dry front pocket with drain holes
- Secret stash travel documents pocket
- Internal mesh stash compartments
- Padded mesh back support
- Padded laptop compartment
- Felt-lined sunnies / phone pockets
- Stationery organiser
- Easy access main compartment



BLACK

**INTERCEPTOR SURF PACK**

AMTS 25

600D Nylon / Polyester Twill

PURPOSE BUILT SURFER'S DAY PACK  
VOLUME: 38 LITRES

- Stretch mesh water bottle sleeve side pocket
- Padded laptop compartment
- Felt-lined sunnies pocket
- Head phone compatible
- Full harness system
- Curved padded shoulder straps
- Padded mesh airflow back
- Internal stationery organiser & ID window
- Side Pockets



BLACK

**AIRCON DOUBLE ZIP BACKPACK**

AMB P35

420D Polyester

LARGE DOUBLE ZIP DAY PACK  
VOLUME: 30 LITRES

- 2 Large separate compartments
- Padded Laptop compartment
- Felt-lined sunnies / phone pocket
- Expandable drink bottle holders
- Stationery organiser
- Reinforced padded base
- A4 compatible



BLACK

**AIRCON SINGLE ZIP**

AMB P29

420D Polyester

SMALL-MED SINGLE ZIP DAY PACK  
VOLUME: 20 LITRES

- Padded laptop compartment
- Felt-lined sunnies / phone pocket
- 2x drink expandable bottle holders
- Stationery organiser
- Reinforced padded base
- A4 compatible



## KEEP IT COOL

### INSULATED HYDRATION PRODUCTS

Keep yourself hydrated and cool with our range of Insulated Hydration products

OCEAN + EARTH 

INSULATED HYDRATION



BLACK

**TRADEY ESKY**  
INSULATED COOLER BAG

AMBP20

VOLUME: 18 LITRES  
FABRIC: ARMOUR WEAVE TEAR PROOF FABRIC

- Inside mesh pockets
- Adjustable shoulder strap
- Water repellent



BLACK

**FREEZE BACKPACK**  
INSULATED COOLER BACKPACK

AMBP36

VOLUME: 30 LITRES  
FABRIC: ARMOUR WEAVE TEAR PROOF FABRIC

- Medium sized Insulated cooler back pack
- Internal welded waterproof seams
- Inside mesh pockets
- Adjustable shoulder strap
- Water repellent



BLACK

**ICE CUBE**  
LARGE INSULATED COOLER BAG

AMBP01

VOLUME: 38 LITRES  
FABRIC: ARMOUR WEAVE TEAR PROOF FABRIC

- Internal welded waterproof seams
- Inside mesh pockets to hold ice bricks
- External wine bottle pockets
- Adjustable shoulder strap
- Water repellent



# INSULATED WATER BOTTLES



BLACK

STEEL BLUE

VIOLET

## INSULATED FLIP LID COFFEE MUG - 350ML

AMWF02

VOLUME: 350ML

- Double-walled vacuum insulation
- Food-grade 18/8 stainless steel
- Easy clean & rust resistant
- BPA & toxin free

INSULATED HYDRATION



INSULATED WATER BOTTLE - 500ML

AMWF06

VOLUME: 500ML

- Double-walled vacuum insulation
- Food-grade 18/8 stainless steel
- Easy clean & rust resistant
- BPA & toxin free

INSULATED SCREW TOP FLASK - 720ML

AMWF08

VOLUME: 720ML

- Double-walled vacuum insulation
- Food-grade 18/8 stainless steel
- Easy clean & rust resistant
- BPA & toxin free

INSULATED SCREW TOP FLASK - 1L

AMWF04

VOLUME: 1L

- Double-walled vacuum insulation
- Food-grade 18/8 stainless steel
- Easy clean & rust resistant
- BPA & toxin free
- Ideal for Beer

INSULATED WATER BOTTLE - 1.9LT

AMWF05

VOLUME: 1.9L

- Double-walled Vacuum Insulation
- Food-grade 18/8 stainless steel
- Easy clean & rust resistant
- BPA & toxin free
- Ideal for Beer

## CANE HATS



NATURAL

### BULA

AMHA01

ABHA01

BOYS

Sizes: S (58cm), M (60cm),  
L (62cm)

Boys Sizes: Reg (55cm),  
Large (57cm)

- Rush Cane
- Inside Comfort Fit Elastic Headband
- Adjustable neck cord



NATURAL

### BULA

ALHA10

LADIES

Sizes: S/M (57cm), M/L (59cm)

- Rush Cane
- Inside Comfort Fit Elastic Headband



NATURAL

**BIG BRIM**

AMHA02

Sizes: S (58cm), M (60cm), L (62cm)

- Rush Cane
- Inside Comfort Fit Elastic Headband
- Adjustable neck cord



NATURAL

**WOODY RAFFIA**

AMHA08

Sizes: S (58cm), M (60cm), L (62cm)

- Raffia Cane
- Inside Comfort Fit Elastic Headband
- Adjustable neck cord



NATURAL

**TROPIC RAFFIA**

AMHA20

Sizes: S (57cm), M (59cm), L (61cm)

- Lightweight Raffia Cane
- Inside Comfort Fit Elastic Headband
- Adjustable Neck Cord



NATURAL

**BREEZE RAFFIA**

ALHA15

LADIES

Sizes: S/M (57cm), M/L (59cm)

- Rush Cane
- Inside Comfort Fit Elastic Headband



COFFEE

**CEBU**

ALHA19

LADIES

Sizes: S/M (57cm), M/L (59cm)

- Crochet Paper Straw
- Inside Comfort Fit Elastic Headband



BEIGE

**BAHAMA**

ALHA18

LADIES

Sizes: S/M (57cm), M/L (59cm)

- Paper Straw
- Inside Comfort Fit Elastic Headband

# CAPS



BLACK

**NEW**  
**BLACK DIAMOND**

AMCA 64

- 6 Panel Strap Back
- Low Profile Curved Peak
- Washed Cotton Twill
- One Size Fits Most



BLACK

**NEW**  
**IGNITE**

AMCA 61

- 5 Panel Strap Back
- Low Profile & Flat Peak
- Washed Cotton Twill
- One Size Fits Most



OLIVE

**NEW**  
**GLOBAL**

AMCA 63

- 5 Panel Snap Back
- Low Profile & Flat Peak
- Washed Cotton Twill
- One Size Fits Most



CHARCOAL



WHITE



NAVY



BLACK



DARK BROWN

**NEW**  
**FUTURISM**

AMCA 65

- 6 Panel Strap Back
- Low Profile Curved Peak
- Washed Cotton Twill
- One Size Fits Most

**NEW**  
**ICON**

AMCA 62

- 6 Panel Strap Back
- Low Profile Curved Peak
- Washed Cotton Twill
- One Size Fits Most

C A P S



BLACK

PETROL

CORP

AMCA57

- 5 Panel Snap Back
- Mid profile
- Washed Cotton Twill
- One Size Fits Most



NAVY

BLACK

BLACK JACK

AMCA52

- 5 Panel Snap Back
- 100% Polyester
- One Size Fits Most



NATURAL

BLUE

DIAMOND CAP

AMCA60

- 5 Panel Strap Back
- Low Profile & Flat Peak
- Washed Cotton Cord
- One Size Fits Most



BLACK

OLIVE

PRIORITY

AMCA31

- 6 Panel Snap Back
- Heavyweight Cotton Twill
- One Size Fits Most



BLACK

MUSHROOM

OLIVE

WAVE HERITAGE CAP

AMCA59

- 5 Panel Strap Back
- Low Profile & Flat Peak
- Washed Cotton Canvas
- One Size Fits Most



BLACK

VINTAGE WHITE

COCOA

ESSENTIAL CAP

AMCA58

- 6 Panel Strap Back
- Low Profile & Curved Peak
- Washed Cotton Twill
- One Size Fits Most

TODDLERS  
ATCA59

\*Mushroom, Olive only

# HATS



## WIDE BRIM

AMHA62

- Floppy Wide Brim Hat
- Draw Cord & Toggle,
- Washed Cotton Twill
- Sizes: S 57cm, M 59cm, L 61cm



BLACK

OLIVE

VINTAGE WHITE

TAN

## CORP BUCKET

AMHA60

- Bucket Hat
- Washed Cotton Canvas
- Sizes: S/M 57cm, M/L 59cm

WALLETS / SUNNY STRAPS



BLACK

ONE DAYER

AMHA11

- Floppy Brim Hat
- Draw Cord & Toggle
- Washed Cotton Twill
- Sizes: S 57cm, M 59cm, L 61cm

DARK OLIVE

SAND

KIDS ONE DAYER

ATHA11

- Sizes: S/M 53cm M/L 55cm
- \*Dark Olive, Sand only



NEOPRENE SUNNIES STRAP

AMMC10



FLOATING SUNNIES STRAP

AMMC09



FORMULA ONE

AMWA07

BI-FOLD WALLET WITH REMOVABLE INTERNAL ID WALLET

- Genuine Leather
- 2 Clear ID windows
- 7 credit card inserts
- Multiple note compartments - 1 with zipper closure
- Snap button coin pocket

# CONTACT

## AUSTRALIA

OCEAN AND EARTH HEAD OFFICE  
Phone: 61 2 4441 2482  
Fax: 61 2 4441 1212  
General Manager / National Sales Manager  
Shawn Macey  
Mobile: 0417 227 776  
email: shawn@oceaneearth.com

SYDNEY NORTHERN BEACHES TO  
ULLADULLA - SOUTH COAST  
Lee Keates  
Mobile: 0467 000 482  
email: lee@oceaneearth.com

SOUTHERN NSW  
Cal Thompson  
Mobile: 0467 000 460  
email: cal@oceaneearth.com

CENTRAL COAST & NORTHERN NSW  
Greg "Hop" Masters  
Mobile: 0424 196 541  
email: hop@oceaneearth.com

QUEENSLAND  
Modern Supply  
Luke Boman  
Mobile 0478 524 221  
email: luke@modernsupply.com.au

VICTORIA & SOUTH AUSTRALIA  
Life Move Sales Agency  
Lachy McDonald  
Mobile: 0408 362 236  
email: lifemoveagency@gmail.com

WESTERN AUSTRALIA  
Rob Bates  
Mob: 0417 982 499  
email: wa@oceaneearth.com

TASMANIA  
Matt Bilsborough  
email: matt@oceaneearth.com

## OCEAN & EARTH EUROPE

Contact: Nuno Amado  
R. Carlos Lopes,  
Albiz Global Parque F  
Albarraque 2635-209  
Portugal  
Phone: +351210998837  
email: nunoamado@oceanandeartheu.com

## OCEAN & EARTH INTERNATIONAL

Contact: Phil MacDonald,  
CEO / International Manager  
macca@oceaneearth.com

CHILE  
SURFERS PARADISE  
Contact: n@surfersparadise.cl

CANARY ISLANDS  
DOWN UNDER S.L  
Contact: fg@downunder.es

CHINA  
OCEAN & EARTH INTERNATIONAL  
Contact: macca@oceaneearth.com

ISRAEL  
HABASAS A FRAME LTD  
Contact: elad\_warz@snf.co.il

INDONESIA  
PT MENIKMATI DISTRIBUTORS  
Contact: macca@oceaneearth.com

JAPAN  
ONE WORLD LTD  
Contact: ssekino@1world.co.jp

SOUTH KOREA  
KAI DISTRIBUTION  
cherylkim2009@gmail.com

MALDIVES  
SEAGULL GROUP P/L  
Contact: nafeela@seagullmaldives.com

NEW ZEALAND  
EXIT SURF  
Contact: ben@exitsurf.com

NORWAY  
FOX DISTRIBUTION  
Contact: seamus@foxdistributions.no

SOUTH AFRICA  
Contact: roddy@kommetjiesurf.com

TAIWAN  
JOHNNY ROSE SURF CO LTD  
Contact: johnysurfshop@yahoo.com.tw

UNITED KINGDOM & IRELAND  
DANIEL SURF LTD  
Contact: matt@danielsurf.com





OCEAN + EARTH

**Trusted by surfers for a lifetime.  
Born in Australia.**

OCEANANDEARTH.COM